



# NORANDEX™

EXTERIOR PRODUCTS FOR YOUR HOME

*See NEW Premium  
Stainless Steel Micro  
Mesh Gutter Screen  
Pg 17*

**RAINWARE, TRIM COIL  
& SIDING ACCESSORIES**

**Apollo Beach Plant**

**[www.acm-metals.com](http://www.acm-metals.com)**



**Table of Contents**

**Norandex™ Rainware Components & Accessories .. 1**

**Norandex™ Rainware Color Selection Chart ..... 2-3**

**Gutter Coil Conversion Chart ..... 4**

**Gutters ..... 5**

    Gutter Coil ..... 5

    Spin Down Gutter Coil ..... 5

**Downspouts ..... 6**

**Elbows..... 7**

**Variable Degree Elbows..... 8**

**Offsets ..... 9**

**Downspout Accessories..... 10**

    Outlets ..... 10

    Drain Tile Adapters ..... 10

    Y Adapters ..... 10

    Downspout Bands ..... 10

    Downspout Clips ..... 10

    Downspout Hinges ..... 10

    Splash Blocks ..... 10

**Miters ..... 11**

    Box Miters ..... 11

    Bay Miters ..... 11

    Strip Miters ..... 11

    Extreme™ Miters ..... 11

**Joints & End Caps ..... 12**

    Expansion Joints ..... 12

    Slip Joints ..... 12

    End Caps ..... 12

**Hangers..... 13-14**

    Hidden ..... 13

    Wrap Around ..... 13

    T-Bar ..... 14

    Hangers with Screws ..... 14

**Rainware Accessories..... 14**

    T-Wedges & Gutter Wedges ..... 14

    Spikes ..... 14

    Ferrules ..... 14

**Round/Half Round Products ..... 15-16**

    Half Round Gutters ..... 15

    Round Downspouts ..... 15

    Round Elbows ..... 16

    Half Round Offsets ..... 16

**Half Round Products ..... 17-18**

    Half Round Outlets ..... 17

    Half Round Miters ..... 17

    Half Round Slip Joints ..... 17

    Half Round End Caps ..... 17

    Half Round Brackets ..... 18

    Half Round Hidden Hangers ..... 18

    Half Round T-Wedge Hangers ..... 18

**Gutter Protection..... 19-21**

    Gutter Protection Screen Systems ..... 19

    Gutter Protection Perforated ..... 20

    & Cover Systems

    Gutter Protection ..... 21

**Norandex™ Trim Coil Color Swatches ..... 22-23**

**Trim Coil..... 24-26**

    Norandex™ - Smooth, PVC, Wood Grain ..... 24

    Pella® - Smooth, PVC, Wood Grain ..... 24

    Mastic Comparable - Smooth, PVC, Wood Grain ..... 24

    James Hardie Comparable - Smooth, PVC, Wood Grain ..... 24

    Certainteed Comparable ..... 25

    Exterior Portfolio Comp. - Smooth, PVC, Wood Grain... 25

    Royal Comparable - Smooth, PVC, Wood Grain ..... 25

    Variform Comparable - Smooth, PVC, Wood Grain .. 25

    Textured, Mar-Resistant Window Trim Coil ..... 25

    Specialty Coils ..... 25

    Allura™ ColorMax® Comp. - Smooth, PVC, Wood Grain . 26

**Fascia ..... 27**

    4" Fascia ..... 27

    6" Fascia ..... 27

    8" Fascia ..... 27

**Soffit ..... 28-29**

    12" Premium Hidden Vent Soffit ..... 28

    12" Double 6 D6 Soffit ..... 28

    12" U-Style Soffit ..... 28

    12" V-Style Soffit ..... 29

    16" V-Style Soffit ..... 29

**Siding Accessories..... 30**

    F-Channel ..... 30

    J-Channel ..... 30

    Starter Strip ..... 30

    Z Flashing ..... 31

    Drip Cap ..... 31

**Warranties ..... 32-34**

**To place orders for metal products, please call:**  
 Apollo Beach Plant Customer Service: **Ph 800-749-4067 • Fax 608-364-0598**  
[www.acm-metals.com](http://www.acm-metals.com)

For siding and window inquiries, please call Norandex™ Corporate Customer Service at **800-528-0942**

# Rainware Components & Accessories



## NORANDEX™

EXTERIOR PRODUCTS FOR YOUR HOME

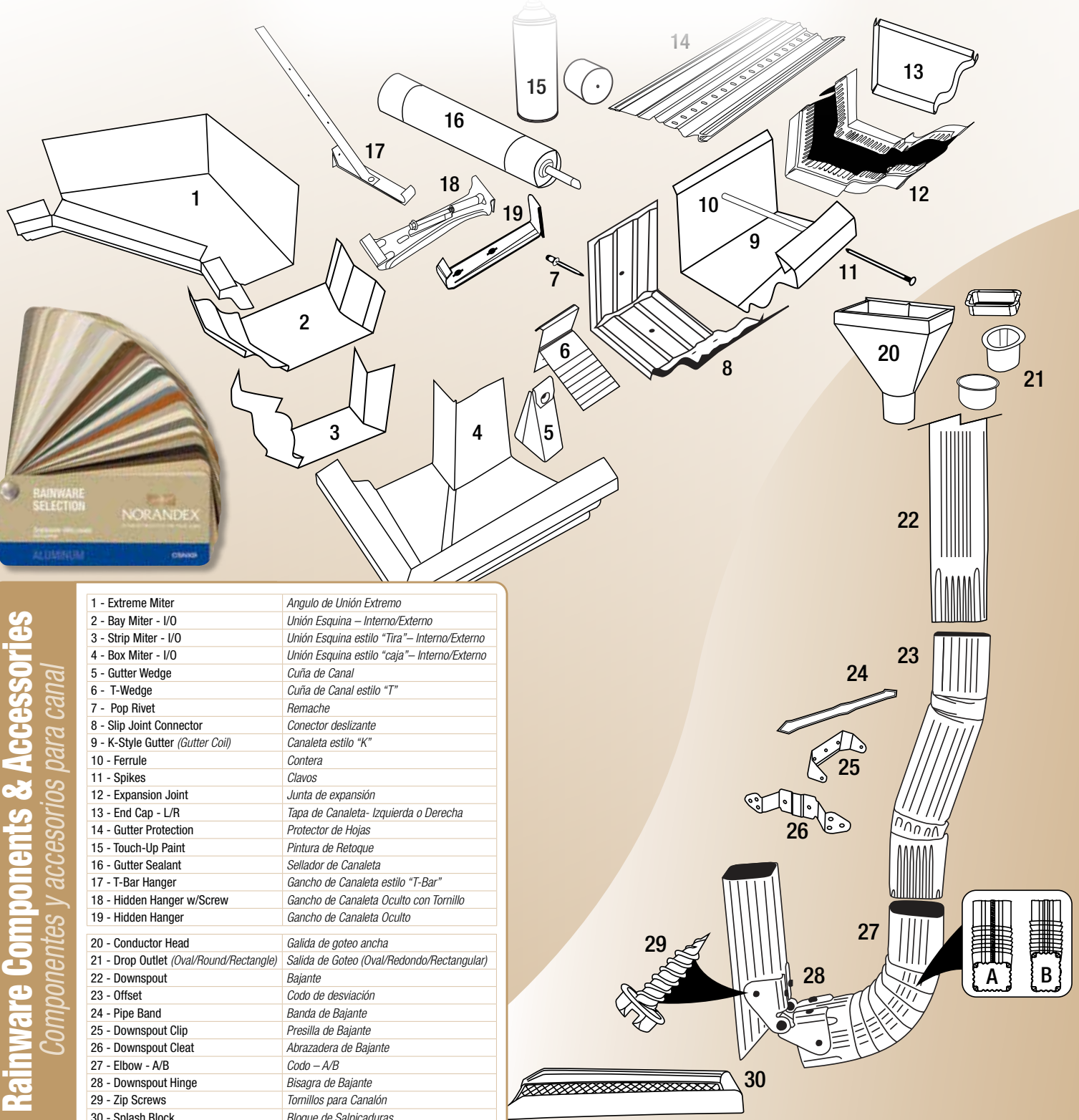

**Rainware Components & Accessories**  
Componentes y accesorios para canal

1 - Extreme Miter	Angulo de Unión Extremo
2 - Bay Miter - I/O	Unión Esquina - Interno/Externo
3 - Strip Miter - I/O	Unión Esquina estilo "Tira" - Interno/Externo
4 - Box Miter - I/O	Unión Esquina estilo "caja" - Interno/Externo
5 - Gutter Wedge	Cuña de Canal
6 - T-Wedge	Cuña de Canal estilo "T"
7 - Pop Rivet	Remache
8 - Slip Joint Connector	Conector deslizante
9 - K-Style Gutter (Gutter Coil)	Canaleta estilo "K"
10 - Ferrule	Contera
11 - Spikes	Clavos
12 - Expansion Joint	Junta de expansión
13 - End Cap - L/R	Tapa de Canaleta- Izquierda o Derecha
14 - Gutter Protection	Protector de Hojas
15 - Touch-Up Paint	Pintura de Retoque
16 - Gutter Sealant	Sellador de Canaleta
17 - T-Bar Hanger	Gancho de Canaleta estilo "T-Bar"
18 - Hidden Hanger w/Screw	Gancho de Canaleta Oculto con Tornillo
19 - Hidden Hanger	Gancho de Canaleta Oculto
20 - Conductor Head	Galida de goteo ancha
21 - Drop Outlet (Oval/Round/Rectangle)	Salida de Goteo (Oval/Redondo/Rectangular)
22 - Downspout	Bajante
23 - Offset	Codo de desviación
24 - Pipe Band	Banda de Bajante
25 - Downspout Clip	Presilla de Bajante
26 - Downspout Cleat	Abrazadera de Bajante
27 - Elbow - A/B	Codo - A/B
28 - Downspout Hinge	Bisagra de Bajante
29 - Zip Screws	Tornillos para Canalón
30 - Splash Block	Bloque de Salpicaduras

# Aluminum RAINWARE Color Selection

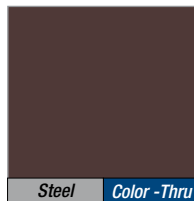

**Royal Brown**  
RB / B6



**Printed Color Swatch** (for color accuracy you need actual metal)

**Color -Thru**



Offering select products in comparable matching colors through Gutter Coil, Rainware, Soffit/Fascia, Trim Coil or Edge Metal product lines.



**Rainware Color Code / Trim Coil Color Code**

**Note:** Actual color may vary from this representation. Please refer to actual metal color swatches for color accuracy. Color appearance may change when viewed at different angles or in sunlight.

**SHERWIN-WILLIAMS®**  
Coil Coatings

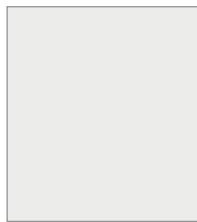

**Frost**  
FR

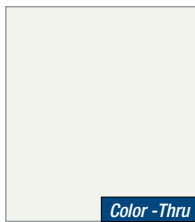

**30 Deg. White**  
WH / W1

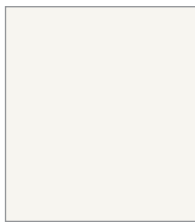

**80 Deg. White**  
80

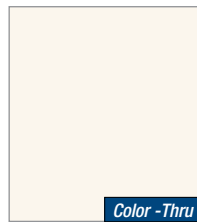

**NX Linen**  
LN / W10

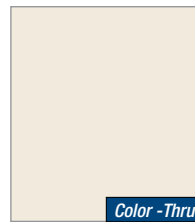

**Linen**  
Li / D4

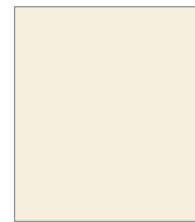

**Egg Shell**  
ES

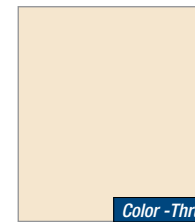

**Cameo**  
CA / W2

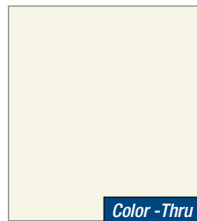

**NX Almond**  
AD / D49



**Desert Sand**  
DS / D34

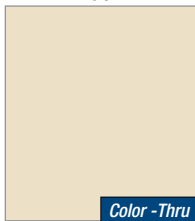

**Almond**  
AL / D14



**Classic Cream**  
CC / D22



**Sandtone**  
ST / D6



**Antique Ivory**  
Ai



**Wicker**  
Wi / D8

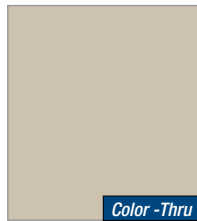

**NX Sand Stone**  
SS / D46



**NX Sierra Clay**  
Si / D47

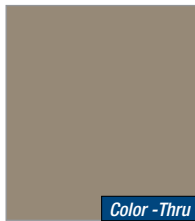

**Pebblestone Clay**  
PC / D5



**Norwegian Wood**  
NW / D26

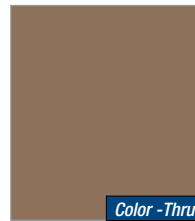

**Buckskin**  
BU / D27



**Montana Suede**  
MS / D44

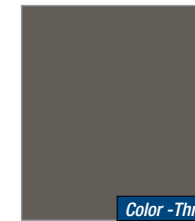

**Terra Bronze**  
TB / B12

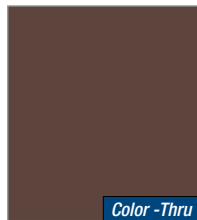

**Beaver Brown**  
BB / B5

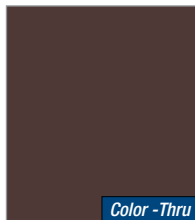

**Royal Brown**  
RB / B6

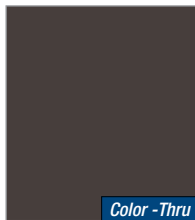

**Musket Brown**  
MB / B1

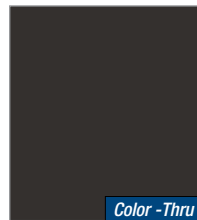

**Bronze**  
BZ / B13

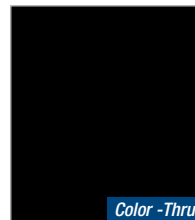

**Black**  
BK / A17



**Tuxedo Grey**  
TX



**Charcoal Grey**  
CG / A8

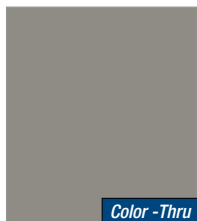

**Harbor Grey**  
HG / A2



**Victorian Grey**  
VG / A5

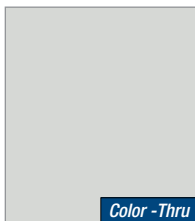

**Silver Grey**  
SG / A3



**Everest**  
EV / A15



**Country Blue**  
CU / L3



**Evergreen**  
EG / G6



**Brookstone**  
BS / D21

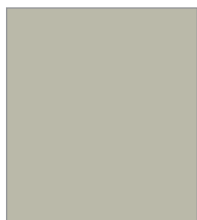

**Sage**  
SA / D25



**Rustic Copper**  
M2 (Premium Color)



**Copper Penny**  
CP

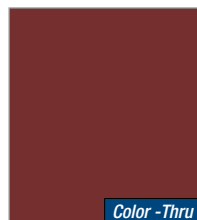

**Redwood**  
RW / R3



**NORANDEX**<sup>TM</sup>

EXTERIOR PRODUCTS FOR YOUR HOME

Aluminum **RAINWARE** Color Selection

*SOUTHEAST REGION*

COLOR GUIDE



## Gutter Coil Conversion Factors

(Determining Feet to Weight)

Coil Width	Nominal Thickness	Conversion Multiplier Formula			
11-3/4"	.027" Alum.	lin. ft. _____	X	.377 = _____	# lbs.
11-7/8"	.027" Alum.	lin. ft. _____	X	.380 = _____	# lbs.
14"	.027" Alum.	lin. ft. _____	X	.453 = _____	# lbs.
15"	.027" Alum.	lin. ft. _____	X	.476 = _____	# lbs.
11-3/4"	.032" Alum.	lin. ft. _____	X	.446 = _____	# lbs.
11-7/8"	.032" Alum.	lin. ft. _____	X	.450 = _____	# lbs.
13"	.032" Alum.	lin. ft. _____	X	.500 = _____	# lbs.
15"	.032" Alum.	lin. ft. _____	X	.571 = _____	# lbs.
18"	.032" Alum.	lin. ft. _____	X	.678 = _____	# lbs.
11-7/8"	26 ga. Steel	lin. ft. _____	X	.768 = _____	# lbs.
12"	26 ga. Steel	lin. ft. _____	X	.775 = _____	# lbs.
13"	26 ga. Steel	lin. ft. _____	X	.839 = _____	# lbs.
14"	26 ga. Steel	lin. ft. _____	X	.904 = _____	# lbs.
15"	26 ga. Steel	lin. ft. _____	X	.969 = _____	# lbs.
19"	26 ga. Steel	lin. ft. _____	X	1.23 = _____	# lbs.
11-7/8"	26 ga. Galvalume	lin. ft. _____	X	.72 = _____	# lbs.
15"	26 ga. Galvalume	lin. ft. _____	X	.90 = _____	# lbs.
11-7/8"	16 oz. Copper	lin. ft. _____	X	.99 = _____	# lbs.
15"	16 oz. Copper	lin. ft. _____	X	1.25 = _____	# lbs.

**For internal use only; this information is not intended for distribution and may not be relied on by any non-ABC or non-ACM party.**

To process an order for a spin down quantity, determine the number of pounds based on the requested footage by the contractor. Enter the number of pounds on the ticket noting the required footage. After spinning down the required coil footage, re-weigh the coil to verify the actual pounds of coil taken out of inventory. Note the actual weight in shipped column of the ticket. Update the tickets to adjust the invoice accordingly. This process ensures proper invoicing and accurate inventory levels.

These coils are cut from master coils which are slightly thicker in the middle to avoid oil canning during the painting process. The gauge can vary slightly depending on where the coil was cut from the master coil. Inventory will vary if the product is sold by footage and not weight. Remember, product is purchased by the pound. Re-weighing is necessary for accuracy.

### A NOTE ABOUT COLOR SELECTION

NORANDEX™ provides color chip cards which show a close representation of the color. The purpose of color chip cards is to narrow down the homeowner choice of colors. Depending upon the substrate, the final selection should always be based on either an aluminum or steel color tile fan deck, viewed in full sunlight. Metallic colors, such as Copper Penny (CP), Bronze (BZ), Rustic Copper (M2), and Weathered Bronze (WB), have mica (refractive) or aluminum (reflective) flakes added to the paint finish. The color of different products may be the same (as measured on a colorimeter), but the visual appearance may look slightly different when viewed from different angles and varying amount of sunlight. This is a normal occurring phenomenon and is due the chance positioning of the mica and aluminum flakes when added to the paint finish.



# NORANDEX Gutters

APOLLO BEACH PLANT

## Gutter Coil

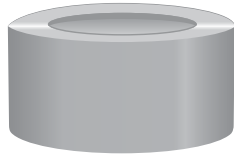

Part #	Description	Colors	Nominal Thickness	Rolls/Pallet
AGC21134 - -	Aluminum 11-3/4" Coil	AD, AL, BB, BK, BZ, BU, CA, CC, CU, DS, EG, FR, HG, LN, LI, MB, NW, PC, RW, RB, M2, SA, ST, SI, SG, TB, VG, WI, WH, 80	0.027	3
AGC21178 - -	Aluminum 11-7/8" Coil	BK, BZ, BU, CA, CG, CP, CU, DS, EV, EG, FR, HG, LN, LI, MB, PC, RW, RB, M2, SS, ST, SI, TB, VG, WI, WH, 80	0.027	3
AGC215 - -	Aluminum 15" Coil	AD, AL, AI, BB, BK, BZ, BS, BU, CA, CG, CC, CP, CU, DS, ES, EV, EG, FR, HG, LN, LI, MS, MB, NW, PC, RW, RB, M2, SS, ST, SI, SG, TB, VG, WI, WH, 80	0.027	2
AGC31134 - -	Aluminum 11-3/4" Coil	AL, AI, BK, BZ, BS, BU, CA, CG, CC, CU, DS, EV, EG, FR, HG, LN, LI, MS, MB, NW, PC, RW, RB, M2, SS, ST, SI, SG, TB, VG, WI, WH, 80	0.032	3
AGC31178 - -	Aluminum 11-7/8" Coil	AD, AL, BB, BK, BZ, BS, BU, CA, CG, CC, CU, DS, ES, EV, EG, FR, HG, LI, MS, MB, NW, PC, RW, RB, M2, SA, SS, ST, SI, SG, TB, VG, WI, WH, 80	0.032	3
AGC315 - -	Aluminum 15" Coil	AL, AI, BB, BK, BZ, BS, CA, CG, CP, ES, EV, FR, LN, LI, MS, MB, PC, RW, RB, M2, SA, TB, WI, WH, 80	0.032	2
*AGC318 - - - -	Aluminum 18" Coil	BK/AL, BZ/FR, ES/80, MB/80, RB/WH, ST/CC	0.032	2

*\*18" Gutter Coil cannot be sold in spin down quantities.*

## Spin Down Gutter Coil



Part #	Description	Colors	Nominal Thickness	Pieces/Pound
ASC21134 - -	Aluminum 11-3/4" Coil	AD, AL, AI, BB, BK, BZ, BU, CA, CC, CU, DS, EG, FR, HG, LN, LI, MB, NW, PC, RW, RB, M2, SA, ST, SI, SG, TB, VG, WI, WH, 80	0.027	Order by the lb.
ASC21178 - -	Aluminum 11-7/8" Coil	BK, BZ, BU, CA, CG, CP, CU, DS, EV, EG, FR, HG, LN, LI, MB, PC, RW, RB, M2, SS, ST, SI, TB, VG, WI, WH, 80	0.027	Order by the lb.
ASC215 - -	Aluminum 15" Coil	AD, AL, AI, BB, BK, BZ, BS, BU, CA, CG, CC, CP, CU, DS, ES, EV, EG, FR, HG, LN, LI, MS, MB, NW, PC, RW, RB, M2, SS, ST, SI, SG, TB, VG, WI, WH, 80	0.027	Order by the lb.
ASC31134 - -	Aluminum 11-3/4" Coil	BK, WI, 80	0.032	Order by the lb.
ASC315 - -	Aluminum 15" Coil	AL, AI, BB, BK, BZ, BS, CA, CG, CP, ES, EV, FR, LN, LI, MS, MB, PC, RW, RB, M2, SA, TB, WI, WH, 80	0.032	Order by the lb.
LSC61178	Galvalume 11-7/8" Coil	Mill	26 ga	Order by the lb.
LSC615	Galvalume 15" Coil	Mill	26 ga	Order by the lb.
CSC21178	Copper 11-7/8" Coil 1'/#	Copper	16 oz	Order by the lb.
CSC215	Copper 15" Coil	Copper	16 oz	Order by the lb.

**Note: Min. of 25 lbs./Max. of 150 lbs.**

*As an extra service, we'll spin down small quantities of a slow moving color on a special order basis. Minimum quantity is 25 lbs.*

*Please note, once order is activated, no returns or changes can be made.*

## Rainware & Accessories Colors

COLOR	CODE	COLOR	CODE	COLOR	CODE	COLOR	CODE	COLOR	CODE
NX ALMOND	AD	CAMEO	CA	EVEREST	EV	NORWEGIAN WOOD	NW	NX SIERRA CLAY	SI
ALMOND	AL	CHARCOAL GREY	CG	EVERGREEN	EG	PEBBLESTONE CLAY	PC	NX SILVER/SILVER GREY	SG
ANTIQUÉ IVORY	AI	CLASSIC CREAM	CC	FROST	FR	REDWOOD	RW	TERRA BRONZE	TB
BEAVER BROWN	BB	COPPER PENNY	CP	HARBOR GREY	HG	ROYAL BROWN	RB	VICTORIAN GREY	VG
BLACK	BK	COUNTRY BLUE	CU	NX LINEN	LN	*RUSTIC COPPER	M2	WICKER	WI
BRONZE	BZ	DESERT SAND	DS	LINEN	LI	SAGE	SA	30 WHITE	WH
BROOKSTONE	BS	EGG SHELL	ES	MONTANA SUEDE	MS	NX SAND STONE	SS	80 WHITE	80
BUCKSKIN	BU			MUSKET BROWN	MB	SANDTONE	ST		

**\*Rustic Copper is a PREMIUM color. NOTE:** Rustic Copper (M2) accessories, including miters and end caps, may display paint finish variations due to the metallic painting process, which may affect matching components.



# NORANDEX™ Downspouts

APOLLO BEACH PLANT

Downspouts		Part #	Description	Colors	Nominal Thickness	Piece Length	Pieces/Box	Boxes/Pallet
ADS238	- -	Aluminum 2 x 3 x 8' DS	(Listed Below)	0.019	8'	*10	28	
ADS238M2		Aluminum 2 x 3 x 8' DS	M2 (Premium Color)	0.019	8'	*10	28	
ADS348	- -	Aluminum 3 x 4 x 8' DS	(Listed Below)	0.019	8'	*10	15	
<i>*Order in full-carton quantities only.</i>								
ADS2310	- -	Aluminum 2 x 3 x 10' DS	(Listed Below)	0.019	10'	10	28	
ADS2310M2		Aluminum 2 x 3 x 10' DS	M2 (Premium Color)	0.019	10'	10	28	
ADS3410	- -	Aluminum 3 x 4 x 10' DS	(Listed Below)	0.019	10'	10	15	
ADS3410M2		Aluminum 3 x 4 x 10' DS	M2 (Premium Color)	0.019	10'	10	15	
ADS23410	- -	Aluminum 3 x 4 x 10' DS	BK, RB, WH	0.024	10'	10	15	
ADS24510	- -	Aluminum 4 x 5 x 10' DS	AL, AI, BK, BZ, CC, ES, FR, MB, RB, ST, SI, TB, WH, 80, WI	0.027	10'	6	15	
LDS3410		Galvalume 3 x 4 x 10' DS	Mill	26 ga	10'	5		
CDS2310		Copper 2 X 3 x 10' DS	Copper	16 oz	10'	Order by the pc.		
CDS3410		Copper 3 x 4 x 10' DS	Copper	16 oz	10'	Order by the pc.		

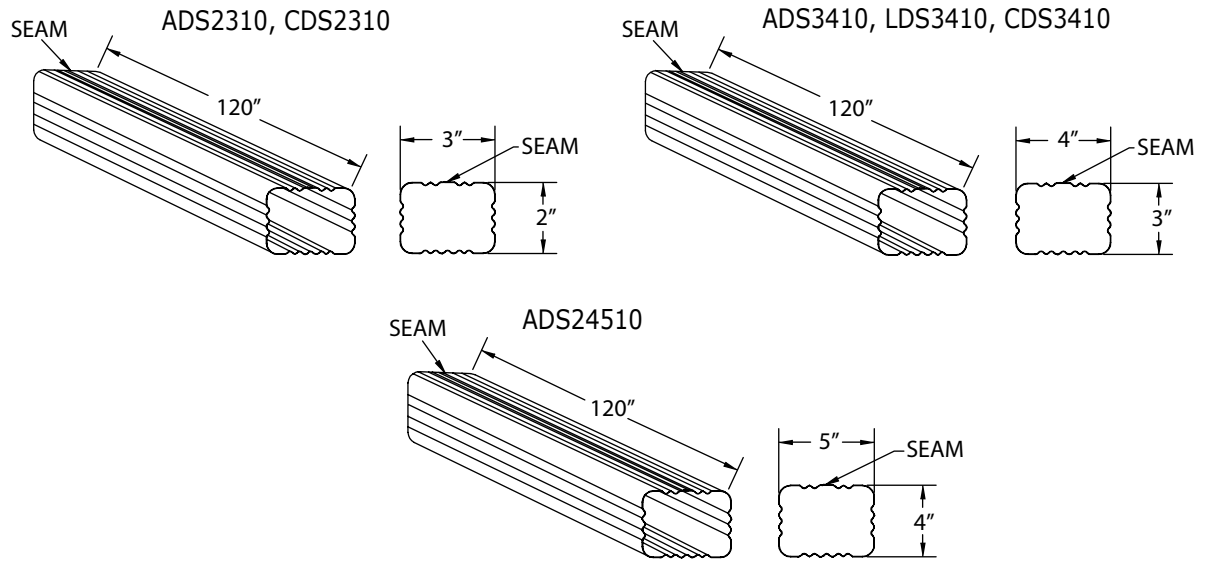

## Rainware & Accessories Colors

COLOR	CODE	COLOR	CODE	COLOR	CODE	COLOR	CODE	COLOR	CODE
NX ALMOND	AD	CAMEO	CA	EVEREST	EV	NORWEGIAN WOOD	NW	NX SIERRA CLAY	SI
ALMOND	AL	CHARCOAL GREY	CG	EVERGREEN	EG	PEBBLESTONE CLAY	PC	NX SILVER/SILVER GREY	SG
ANTIQUE IVORY	AI	CLASSIC CREAM	CC	FROST	FR	REDWOOD	RW	TERRA BRONZE	TB
BEAVER BROWN	BB	COPPER PENNY	CP	HARBOR GREY	HG	ROYAL BROWN	RB	VICTORIAN GREY	VG
BLACK	BK	COUNTRY BLUE	CU	NX LINEN	LN	*RUSTIC COPPER	M2	WICKER	WI
BRONZE	BZ	DESERT SAND	DS	LINEN	LI	SAGE	SA	30 WHITE	WH
BROOKSTONE	BS	EGG SHELL	ES	MONTANA SUEDE	MS	NX SAND STONE	SS	80 WHITE	80
BUCKSKIN	BU			MUSKET BROWN	MB	SANDTONE	ST		



**\*Rustic Copper is a PREMIUM color. NOTE:** Rustic Copper (M2) accessories, including miters and end caps, may display paint finish variations due to the metallic painting process, which may affect matching components.





# NORANDEX™ Elbows

APOLLO BEACH PLANT

Elbows	Part #	Description	Colors	Nominal Thickness	Piece Length	Pieces/Box	Boxes/Pallet
	AAE23 - -	Aluminum 2 x 3 A Elbow	*(Listed Below)	0.019	10-9/16"	30	32
	AAE23M2	Aluminum 2 x 3 A Elbow	M2 (Premium Color)	0.019	10-9/16"	30	32
	AAE34 - -	Aluminum 3 x 4 A Elbow	(Listed Below)	0.019	12-3/4"	30	16
	AAE34M2	Aluminum 3 x 4 A Elbow	M2 (Premium Color)	0.019	12-3/4"	30	16
	AAE234 - -	Aluminum 2 x 3 A Elbow	(Listed Below)	0.024	10-9/16"	30	32
	AAE245 - -	Aluminum 4 x 5 A Elbow	AL, AI, BK, BZ, CC, ES, FR, MB, RB, ST, SI, TB, WH, 80, WI	0.027	15-1/2"	9	12
	ABE23 - -	Aluminum 2 x 3 B Elbow	*(Listed Below)	0.019	11-1/2"	30	32
	ABE23M2	Aluminum 2 x 3 B Elbow	M2 (Premium Color)	0.019	11-1/2"	30	32
	ABE34 - -	Aluminum 3 x 4 B Elbow	(Listed Below)	0.019	15"	30	16
	ABE34M2	Aluminum 3 x 4 B Elbow	M2 (Premium Color)	0.019	15"	30	16
	ABE234 - -	Aluminum 2 x 3 B Elbow	(Listed Below)	0.024	11-1/2"	30	32
	ABE245 - -	Aluminum 4 x 5 B Elbow	AL, AI, BK, BZ, CC, ES, FR, MB, RB, ST, SI, TB, WH, 80, WI	0.027	15-3/4"	9	12
	LAE34 - -	Galvalume 3 x 4 A Elbow	Mill	26 ga	12-3/4"	30	
	LBE34 - -	Galvalume 3 x 4 B Elbow	Mill	26 ga	15"	30	
	CAE23	Copper 2 x 3 A Elbow	Copper	16 oz	10-9/16"Order by the pc.		
	CAE34	Copper 3 x 4 A Elbow	Copper	16 oz	12-3/4"Order by the pc.		
	CBE23	Copper 2 x 3 B Elbow	Copper	16 oz	11-1/2"Order by the pc.		
	CBE34	Copper 3 x 4 B Elbow	Copper	16 oz	15" Order by the pc.		

\*AAE23 - - & ABE23 - - not available in ES, SG.

AAE23 A-Elbow

ABE23 B-Elbow

AAE34, CAE34 A-Elbow

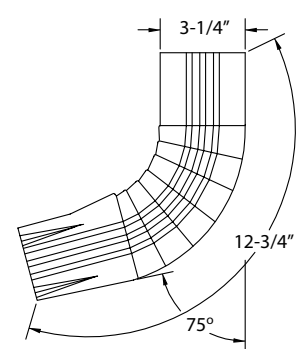
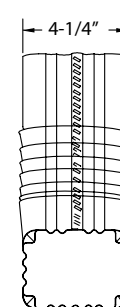
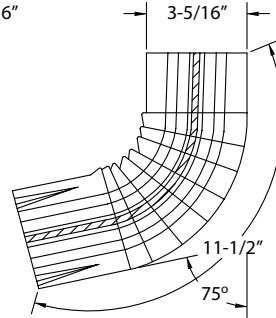
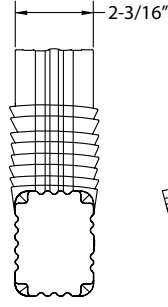
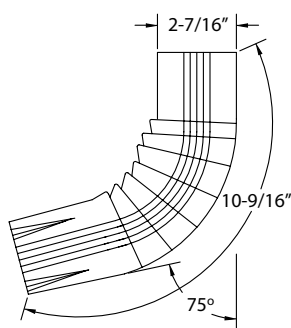
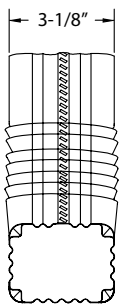

ABE34, CBE34 B-Elbow

AAE245 A-Elbow

ABE245 B-Elbow

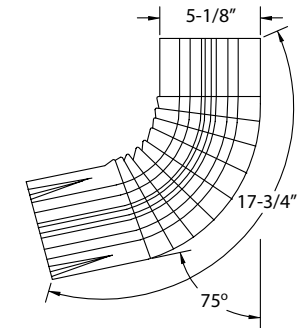
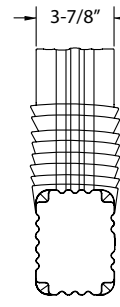
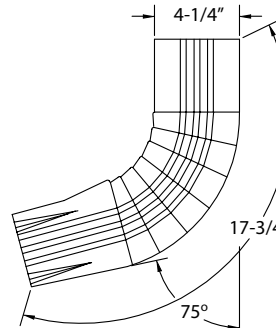
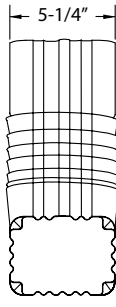
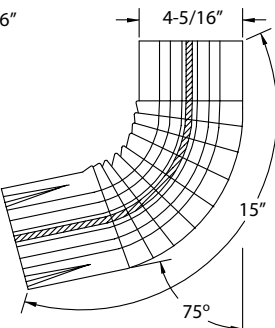
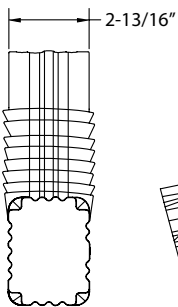

## Rainware & Accessories Colors

COLOR	CODE	COLOR	CODE	COLOR	CODE	COLOR	CODE	COLOR	CODE
NX ALMOND	AD	CAMEO	CA	EVEREST	EV	NORWEGIAN WOOD	NW	NX SIERRA CLAY	SI
ALMOND	AL	CHARCOAL GREY	CG	EVERGREEN	EG	PEBBLESTONE CLAY	PC	NX SILVER/SILVER GREY	SG
ANTIQUÉ IVORY	AI	CLASSIC CREAM	CC	FROST	FR	REDWOOD	RW	TERRA BRONZE	TB
BEAVER BROWN	BB	COPPER PENNY	CP	HARBOR GREY	HG	ROYAL BROWN	RB	VICTORIAN GREY	VG
BLACK	BK	COUNTRY BLUE	CU	NX LINEN	LN	*RUSTIC COPPER	M2	WICKER	WI
BRONZE	BZ	DESERT SAND	DS	LINEN	LI	SAGE	SA	30 WHITE	WH
BROOKSTONE	BS	EGG SHELL	ES	MONTANA SUEDE	MS	NX SAND STONE	SS	80 WHITE	80
BUCKSKIN	BU			MUSKET BROWN	MB	SANDTONE	ST		

\*Rustic Copper is a PREMIUM color. NOTE: Rustic Copper (M2) accessories, including miters and end caps, may display paint finish variations due to the metallic painting process, which may affect matching components.



# NORANDEX™ Variable Degree Elbows

APOLLO BEACH PLANT

## Variable Degree Elbows

This chart shows the roof pitch paired to the approximate variable degree elbow.

ROOF PITCH	DEGREE
Mansard	15°
18/12	22°
16/12	22°
14/12	22°
12/12	30°
10/12	45°
8/12	45°
6/12	45°
4/12	75°

Variable degree elbows are used to go around obstructions (ledge jumpers) or transition to the slope of the roof.

Part #	Description	Colors	Nominal Thickness	Piece Length	Pieces/Box	Boxes/Pallet
AAE123 - -	Aluminum 2 x 3 V/D A Elbow 15°	(Listed Below)	0.019	6-1/4"	30	32
AAE2223 - -	Aluminum 2 x 3 V/D A Elbow 22°	(Listed Below)	0.019	6-3/4"	30	16
AAE323 - -	Aluminum 2 x 3 V/D A Elbow 30°	(Listed Below)	0.019	(7.19)"	30	16
AAE423 - -	Aluminum 2 x 3 V/D A Elbow 45°	(Listed Below)	0.019	(7.94)"	30	16
AAE923 - -	Aluminum 2 x 3 V/D A Elbow 90°	(Listed Below)	0.019		30	--
AAE134 - -	Aluminum 3 x 4 V/D A Elbow 15°	(Listed Below)	0.019		30	8
AAE2234 - -	Aluminum 3 x 4 V/D A Elbow 22°	(Listed Below)	0.019		30	16
AAE334 - -	Aluminum 3 x 4 V/D A Elbow 30°	(Listed Below)	0.019		30	16
AAE434 - -	Aluminum 3 x 4 V/D A Elbow 45°	(Listed Below)	0.019		30	16
AAE934 - -	Aluminum 3 x 4 V/D A Elbow 90°	(Listed Below)	0.019		30	16
AAE3245ES	Aluminum 4 x 5 V/D A Elbow 30°	ES, MB	0.027		9	12
AAE2445 - -	Aluminum 4 x 5 V/D A Elbow 45°	AL, BK, BZ, CC, ES, FR, MB, RB, ST, *TB, WH, 80	0.027		9	12
ABE123 - -	Aluminum 2 x 3 V/D B Elbow 15°	(Listed Below)	0.019	6-1/4"	30	16
ABE2223 - -	Aluminum 2 x 3 V/D B Elbow 22°	(Listed Below)	0.019	6-3/4"	30	16
ABE323 - -	Aluminum 2 x 3 V/D B Elbow 30°	(Listed Below)	0.019	(7.19)"	30	16
ABE423 - -	Aluminum 2 x 3 V/D B Elbow 45°	(Listed Below)	0.019	(7.94)"	30	16
ABE923 - -	Aluminum 2 x 3 V/D B Elbow 90°	(Listed Below)	0.019		30	--
ABE134 - -	Aluminum 3 x 4 V/D B Elbow 15°	(Listed Below)	0.019		30	8
ABE2234 - -	Aluminum 3 x 4 V/D B Elbow 22°	(Listed Below)	0.019		30	16
ABE334 - -	Aluminum 3 x 4 V/D B Elbow 30°	(Listed Below)	0.019		30	16
ABE434 - -	Aluminum 3 x 4 V/D B Elbow 45°	(Listed Below)	0.019		30	16
ABE934 - -	Aluminum 3 x 4 V/D B Elbow 90°	(Listed Below)	0.019		30	16
ABE2445 - -	Aluminum 4 x 5 V/D B Elbow 45°	AL, BK, BZ, CC, ES, FR, MB, RB, ST, *TB, WH, 80	0.027		9	12
LAE334	Galvalume 3 x 4 V/D A Elbow 30°	Mill	26 ga	15"	30	
LBE334	Galvalume 3 x 4 V/D B Elbow 30°	Mill	26 ga	15"	30	

\*Note: Extended lead time required for this part in this color.

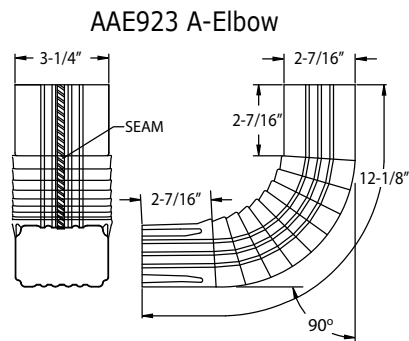
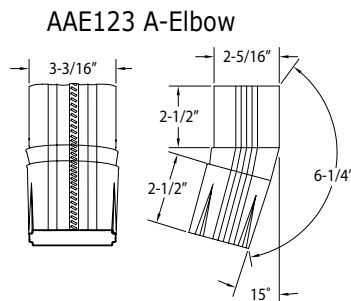

## Rainware & Accessories Colors

COLOR	CODE	COLOR	CODE	COLOR	CODE	COLOR	CODE	COLOR	CODE
NX ALMOND	AD	CHARCOAL GREY	CG	EVERGREEN	EG	PEBBLESTONE CLAY	PC	TERRA BRONZE	TB
ALMOND	AL	CLASSIC CREAM	CC	FROST	FR	REDWOOD	RW	VICTORIAN GREY	VG
BEAVER BROWN	BB	COPPER PENNY	CP	HARBOR GREY	HG	ROYAL BROWN	RB	WICKER	WI
BLACK	BK	COUNTRY BLUE	CU	NX LINEN	LN	SAGE	SA	30 WHITE	WH
BRONZE	BZ	DESERT SAND	DS	LINEN	LI	NX SAND STONE	SS	80 WHITE	80
BROOKSTONE	BS	EGG SHELL	ES	MONTANA SUEDE	MS	SANDTONE	ST		
BUCKSKIN	BU	EVEREST	EV	MUSKET BROWN	MB	NX SIERRA CLAY	SI		
CAMEO	CA			NORWEGIAN WOOD	NW	NX SILVER/SILVER GREY	SG		



# NORANDEX™ Offsets

APOLLO BEACH PLANT

## Offsets

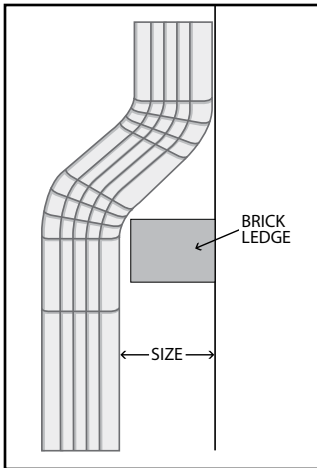

We have several varieties of offset downspout connections to transition gracefully over a brick ledge. You can eliminate the awkward look of a two-piece configuration with our choice of 1" to 6" away-from-the-wall options.

Part #	Description	Colors	Nominal Thickness	Pieces/Box
ABO2A23A	Alum. Brickledge Offsets (2 pc.) 2 x 3 A's, 4 Crimps 45°	*(Listed Below)	0.019	18 pcs./9 sets
ABO2A34A	Alum. Brickledge Offsets (2 pc.) 3 x 4 A's, 3 Crimps 45°	*(Listed Below)	0.019	18 pcs./9 sets
ABO1123A	Aluminum 2 x 3 - 1" A Offset	(Listed Below)	0.019	24
ABO1223A	Aluminum 2 x 3 - 2" A Offset	(Listed Below)	0.019	24
ABO1323A	Aluminum 2 x 3 - 3" A Offset	(Listed Below)	0.019	24
ABO1423A	Aluminum 2 x 3 - 4" A Offset	(Listed Below)	0.019	20
ABO1523A	Aluminum 2 x 3 - 5" A Offset	(Listed Below)	0.019	20
ABO1623A	Aluminum 2 x 3 - 6" A Offset	(Listed Below)	0.019	20
ABO1134A	Aluminum 3 x 4 - 1" A Offset	(Listed Below)	0.019	24
ABO1234A	Aluminum 3 x 4 - 2" A Offset	(Listed Below)	0.019	24
ABO1334A	Aluminum 3 x 4 - 3" A Offset	(Listed Below)	0.019	24
ABO1434A	Aluminum 3 x 4 - 4" A Offset	(Listed Below)	0.019	20
ABO1534A	Aluminum 3 x 4 - 5" A Offset	(Listed Below)	0.019	20
ABO1634A	Aluminum 3 x 4 - 6" A Offset	(Listed Below)	0.019	20
LBO1234A	Galvalume 3 x 4 - 2" A Offset	Mill	28 ga	24
LBO1534A	Galvalume 3 x 4 - 5" A Offset	Mill	28 ga	20
ABO1145A	Aluminum 4 x 5 - 1" A's	AL, AI, BK, BZ, CC, ES, FR, MB, RB, ST, SI, TB, WH, 80, WI	0.027	9
ABO1245A	Aluminum 4 x 5 - 2" A's	AL, AI, BK, BZ, CC, ES, FR, MB, RB, ST, SI, TB, WH, 80, WI	0.027	9
ABO1345A	Aluminum 4 x 5 - 3" A's	AL, AI, BK, BZ, CC, ES, FR, MB, RB, ST, SI, TB, WH, 80, WI	0.027	9
ABO1445A	Aluminum 4 x 5 - 4" A's	AL, AI, BK, BZ, CC, ES, FR, MB, RB, ST, SI, TB, WH, 80, WI	0.027	9
ABO1545A	Aluminum 4 x 5 - 5" A's	AL, AI, BK, BZ, CC, ES, FR, MB, RB, ST, SI, TB, WH, 80, WI	0.027	9
ABO1645A	Aluminum 4 x 5 - 6" A's	AL, AI, BK, BZ, CC, ES, FR, MB, RB, ST, SI, TB, WH, 80, WI	0.027	9

All "A" Offsets also available in "B" profiles.

\*Note: ABO2A34A not available in SI.

ABO1123A A-Offset

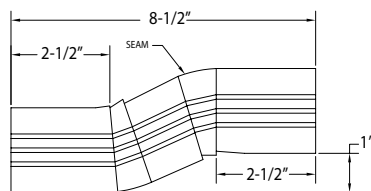

ABO1134A A-Offset

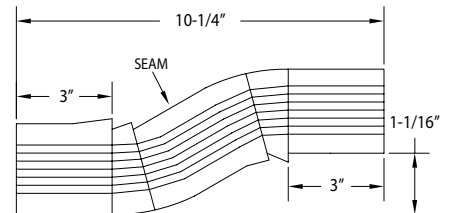

ABO2A23A A-Offset

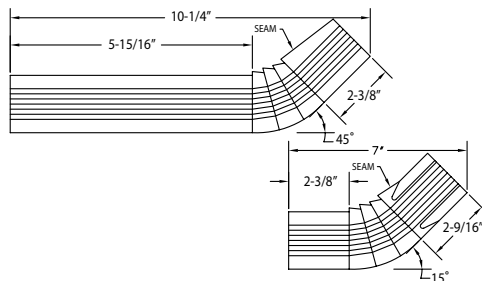

ABO2A34A A-Offset

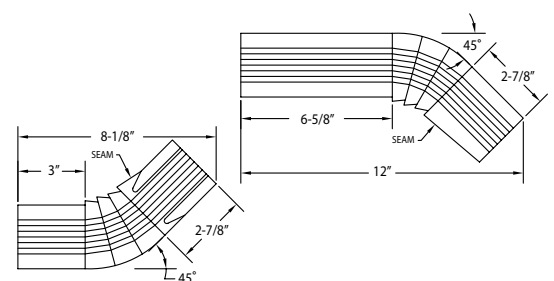

## Rainware & Accessories Colors

COLOR	CODE	COLOR	CODE	COLOR	CODE	COLOR	CODE	COLOR	CODE
NX ALMOND	AD	CAMEO	CA	EVEREST	EV	NORWEGIAN WOOD	NW	NX SILVER/SILVER GREY	SG
ALMOND	AL	CHARCOAL GREY	CG	EVERGREEN	EG	PEBBLESTONE CLAY	PC	TERRA BRONZE	TB
ANTIQUÉ IVORY	AI	CLASSIC CREAM	CC	FROST	FR	REDWOOD	RW	VICTORIAN GREY	VG
BEAVER BROWN	BB	COPPER PENNY	CP	HARBOR GREY	HG	ROYAL BROWN	RB	WICKER	WI
BLACK	BK	COUNTRY BLUE	CU	NX LINEN	LN	SAGE	SA	30 WHITE	WH
BRONZE	BZ	DESERT SAND	DS	LINEN	LI	NX SAND STONE	SS	80 WHITE	80
BROOKSTONE	BS	EGG SHELL	ES	MONTANA SUEDE	MS	SANDTONE	ST		
BUCKSKIN	BU			MUSKET BROWN	MB	NX SIERRA CLAY	SI		



# NORANDEX™ Downspout Accessories

APOLLO BEACH PLANT

## Outlets

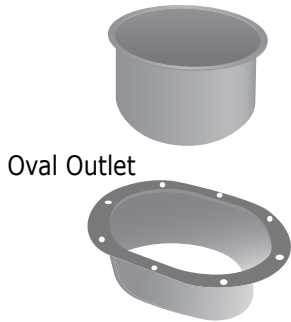

Oval Outlet

Part #	Description	Colors	Nominal Thickness	Pieces/ Box
AORE23ML	Aluminum 2 x 3 Rectangle Outlet	*		30
AORE34ML	Aluminum 3 x 4 Rectangle Outlet	*		50
AORE45ML	Aluminum 4 x 5 Rectangle Outlet	*		50
AORO238ML	Aluminum 2-3/8" Round Outlet	*		250
AORO234ML	Aluminum 2-3/4" Round Narrow Flange Outlet	*		250
AORO338ML	Aluminum 3-3/8" Round Outlet	*		100
AOOV23ML	Aluminum 2 x 3 Oval Outlet	*		30
AOOV34ML	Aluminum 3 x 4 Oval Outlet	*		50
CORE34	Copper 3 x 4 Rectangle Outlet	Copper	16 oz	Order by the pc.

**\*NOTE:** Aluminum outlets made with mill or painted finish per manufacturer's discretion.

## Drain Tile Adapters

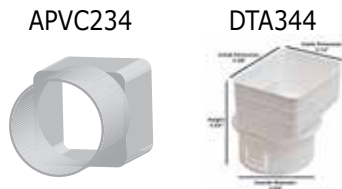

APVC234

DTA344

Part #	Description	Colors	Pieces/ Box
APVC234WH	PVC 2 x 3 x 4 Flush Mount Adapter	WH	12
DTA344 - -	High Density Polyethylene 3x4 Adapter	BK	24

## Y Adapters



Part #	Description	Colors	Nominal Thickness	Pieces/ Box
AYA34WH	Aluminum 3 x 4 "Y" Adapter	WH	0.019	10

## Downspout Bands



Part #	Description	Colors	Nominal Thickness	Pieces/ Box
ADSPB34 - -	Aluminum 3 x 4 Universal DS Band	(Listed Below)	0.019	100

## Downspout Clips



Part #	Description	Colors	Nominal Thickness	Pieces/ Box
ADSCP23 - -	Aluminum 2 x 3 DS Clip	WH	0.032	100
ADSCP34 - -	Aluminum 3 x 4 DS Clip	WH	0.032	50
ADSCP34M2	Aluminum 3 x 4 DS Clip	M2 (Premium Color)	0.032	50

**\*Rustic Copper is a PREMIUM color. NOTE:** Rustic Copper (M2) accessories, including miters and end caps, may display paint finish variations due to the metallic painting process, which may affect matching components.

## Downspout Hinges

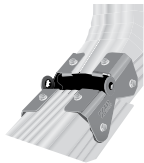

Part #	Description	Colors	Pairs/ Bag
AZHWH	Aluminum 2 x 3 / 3 x 4 Zip Hinge	WH	12 pairs

## Splash Blocks

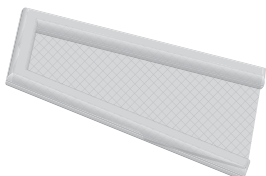

Part #	Description	Colors	Pieces/ Box
SBGN	Splash Block - Green	GN	Order by the pc. 10 pcs./box

# NORANDEX™ Miters

APOLLO BEACH PLANT

## Box Miters

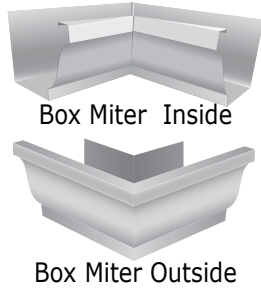

Part #	Description	Colors	Nominal Thickness	Pieces/Box
ABM5I - -	Aluminum 5" Inside Miter	(Listed Below)	0.019	20
ABM5O - -	Aluminum 5" Outside Miter	(Listed Below)	0.019	20
ABM5IM2	Aluminum 5" Inside Miter	M2 (Premium Color)	0.019	20
ABM5OM2	Aluminum 5" Outside Miter	M2 (Premium Color)	0.019	20
ABM6I - -	Aluminum 6" Inside Miter	(Listed Below)	0.019	20
ABM6O - -	Aluminum 6" Outside Miter	(Listed Below)	0.019	20
ABM6IM2	Aluminum 6" Inside Miter	M2 (Premium Color)	0.019	20
ABM6OM2	Aluminum 6" Outside Miter	M2 (Premium Color)	0.019	20
LBM6I	Galvalume 6" Inside	Mill	26 ga	20
LBM6O	Galvalume 6" Outside	Mill	26 ga	20

## Bay Miters

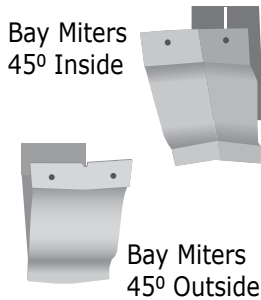

Part #	Description	Colors	Nominal Thickness	Pieces/Box
ABY5I - -	Aluminum 5" Inside Bay Miter	(Listed Below)	0.019	20
ABY5O - -	Aluminum 5" Outside Bay Miter	(Listed Below)	0.019	20
ABY5IM2	Aluminum 5" Inside Bay Miter	M2 (Premium Color)	0.019	20
ABY5OM2	Aluminum 5" Outside Bay Miter	M2 (Premium Color)	0.019	20
ABY6I - -	Aluminum 6" Inside Bay Miter	(Listed Below)	0.019	20
ABY6O - -	Aluminum 6" Outside Bay Miter	(Listed Below)	0.019	20
ABY6IM2	Aluminum 6" Inside Bay Miter	M2 (Premium Color)	0.019	20
ABY6OM2	Aluminum 6" Outside Bay Miter	M2 (Premium Color)	0.019	20
ABY7I - -	Aluminum 7" Inside Bay Miter	BZ, CC, ES, FR, RB, ST, WH, 80	0.019	20
ABY7O - -	Aluminum 7" Outside Bay Miter	BZ, CC, ES, FR, RB, ST, WH, 80	0.019	20
LBY6I	Galvalume 6" Inside Bay Miter	Mill	26 ga	20
LBY6O	Galvalume 6" Outside Bay Miter	Mill	26 ga	20
CBY6I	Copper 6" Inside Bay Miter	Copper	16 oz	Order by the pc.
CBY6O	Copper 6" Outside Bay Miter	Copper	16 oz	Order by the pc.

## Strip Miters

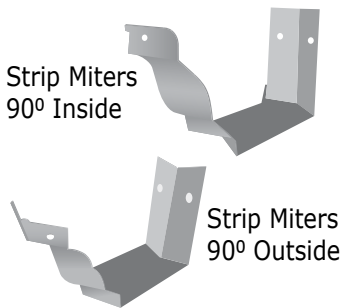

Part #	Description	Colors	Nominal Thickness	Pieces/Box
ASM5I - -	Aluminum 5" Inside Strip Miter	(Listed Below)	0.027	20
ASM5O - -	Aluminum 5" Outside Strip Miter	(Listed Below)	0.027	20
ASM5IM2	Aluminum 5" Inside Strip Miter	M2 (Premium Color)	0.027	20
ASM5OM2	Aluminum 5" Outside Strip Miter	M2 (Premium Color)	0.027	20
ASM6I - -	Alum. 6" Inside Strip Miter	(Listed Below)	0.027	20
ASM6O - -	Alum. 6" Outside Strip Miter	(Listed Below)	0.027	20
ASM6IM2	Alum. 6" Inside Strip Miter	M2 (Premium Color)	0.027	20
ASM6OM2	Alum. 6" Outside Strip Miter	M2 (Premium Color)	0.027	20
ASM7I - -	Aluminum 7" Inside Strip Miter	BZ, CC, ES, FR, RB, ST, WH, 80	0.027	20
ASM7O - -	Aluminum 7" Outside Strip Miter	BZ, CC, ES, FR, RB, ST, WH, 80	0.027	20
LSM5I	Galvalume 5" Inside Strip Miter	Mill	26 ga	20
LSM5O	Galvalume 5" Outside Strip Miter	Mill	26 ga	20
LSM6I	Galvalume 6" Inside Strip Miter	Mill	26 ga	20
LSM6O	Galvalume 6" Outside Strip Miter	Mill	26 ga	20
CSM6I	Copper 6" Inside Strip Miter	Copper	16 oz	Order by the pc.
CSM6O	Copper 6" Outside Strip Miter	Copper	16 oz	Order by the pc.

## Extreme Miter™



Part #	Description	Colors	Nominal Thickness	Pieces/Box
AEM5 - -	Aluminum 5" Extreme Miter™	RB, WH, 80	0.019	10
AEM6WH	Aluminum 6" Extreme Miter™	WH	0.019	10

## Rainware & Accessories Colors

COLOR	CODE	COLOR	CODE	COLOR	CODE	COLOR	CODE	COLOR	CODE
NX ALMOND	AD	CAMEO	CA	EVEREST	EV	NORWEGIAN WOOD	NW	NX SIERRA CLAY	SI
ALMOND	AL	CHARCOAL GREY	CG	EVERGREEN	EG	PEBBLESTONE CLAY	PC	NX SILVER/SILVER GREY	SG
ANTIQUE IVORY	AI	CLASSIC CREAM	CC	FROST	FR	REDWOOD	RW	TERRA BRONZE	TB
BEAVER BROWN	BB	COPPER PENNY	CP	HARBOR GREY	HG	ROYAL BROWN	RB	VICTORIAN GREY	VG
BLACK	BK	COUNTRY BLUE	CU	NX LINEN	LN	*RUSTIC COPPER	M2	WICKER	WI
BRONZE	BZ	DESERT SAND	DS	LINEN	LI	SAGE	SA	30 WHITE	WH
BROOKSTONE	BS	EGG SHELL	ES	MONTANA SUEDE	MS	NX SAND STONE	SS	80 WHITE	80
BUCKSKIN	BU			MUSKET BROWN	MB	SANDTONE	ST		

\*Rustic Copper is a PREMIUM color. NOTE: Rustic Copper (M2) accessories, including miters and end caps, may display paint finish variations due to the metallic painting process, which may affect matching components.



# NORANDEX™ Expansion & Slip Joints & End Caps

APOLLO BEACH PLANT

## Expansion Joints

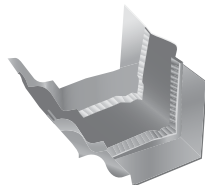

Part #	Description	Colors	Nominal Thickness	Pieces/Box
AEJ5ML	Aluminum 5" Expansion Joint	Mill	0.030	12
AEJ6ML	Aluminum 6" Expansion Joint	Mill	0.030	12

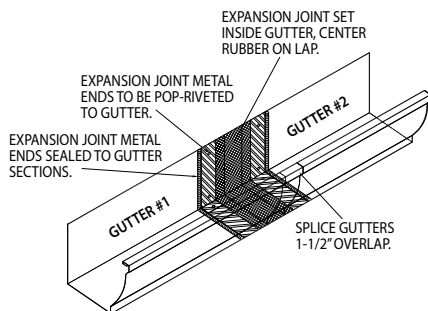

A 50' section of gutter can potentially expand almost 2/3 of an inch from winter to summer causing gutters to buckle. Expansion joints are a preventive measure for excessive movement in the gutter, and should be mounted in place every 50' of exceptionally long gutter runs.

## Slip Joints



Part #	Description	Colors	Nominal Thickness	Pieces/Box
ASJC5 - -	Aluminum 5" Slip Joint	RB, WH	0.019	Order by the pc.

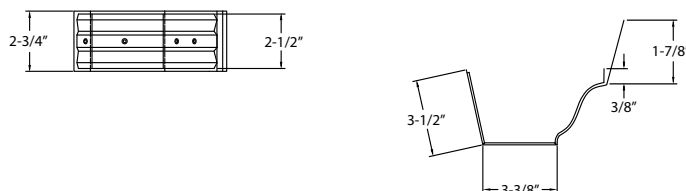

## End Caps

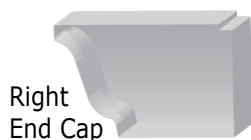

Part #	Description	Colors	Nominal Thickness	Piece Length	Pieces/Box
AEC5L - -	Aluminum 5" Left End Cap - K-Style	(Listed Below)	0.019	5"	50
AEC5R - -	Aluminum 5" Right End Cap - K-Style	(Listed Below)	0.019	5"	50
AEC5LM2	Aluminum 5" Left End Cap - K-Style M2 (Premium Color)		0.019	5"	50
AEC5RM2	Aluminum 5" Right End Cap - K-Style M2 (Premium Color)		0.019	5"	50
AEC6L - -	Aluminum 6" Left End Cap - K-Style	(Listed Below)	0.019	6"	50
AEC6R - -	Aluminum 6" Right End Cap - K-Style	(Listed Below)	0.019	6"	50
AEC6LM2	Aluminum 6" Left End Cap - K-Style M2 (Premium Color)		0.019	6"	50
AEC6RM2	Aluminum 6" Right End Cap - K-Style M2 (Premium Color)		0.019	6"	50
AEC7L - -	Aluminum 7" Left End Cap - K-Style	BZ, CC, ES, FR, MB, RB, ST, WH, 80	0.027	7"	25
AEC7R - -	Aluminum 7" Right End Cap - K-Style	BZ, CC, ES, FR, MB, RB, ST, WH, 80	0.027	7"	25
LEC5L	Galvalume 5" Left End Cap - K-Style	Mill	26 ga	5"	50
LEC5R	Galvalume 5" Right End Cap - K-Style	Mill	26 ga	5"	50
LEC6L	Galvalume 6" Left End Cap - K-Style	Mill	26 ga	6"	50
LEC6R	Galvalume 6" Right End Cap - K-Style	Mill	26 ga	6"	50
CEC5L	Copper 5" Left End Cap - K-Style	Copper	16 oz	5"	Order by the pc.
CEC5R	Copper 5" Right End Cap - K-Style	Copper	16 oz	5"	Order by the pc.
CEC6L	Copper 6" Left End Cap - K-Style	Copper	16 oz	6"	Order by the pc.
CEC6R	Copper 6" Right End Cap - K-Style	Copper	16 oz	6"	Order by the pc.

## Rainware & Accessories Colors

COLOR	CODE	COLOR	CODE	COLOR	CODE	COLOR	CODE	COLOR	CODE
NX ALMOND	AD	CAMEO	CA	EVEREST	EV	NORWEGIAN WOOD	NW	NX SIERRA CLAY	SI
ALMOND	AL	CHARCOAL GREY	CG	EVERGREEN	EG	PEBBLESTONE CLAY	PC	NX SILVER/SILVER GREY	SG
ANTIQUE IVORY	AI	CLASSIC CREAM	CC	FROST	FR	REDWOOD	RW	TERRA BRONZE	TB
BEAVER BROWN	BB	COPPER PENNY	CP	HARBOR GREY	HG	ROYAL BROWN	RB	VICTORIAN GREY	VG
BLACK	BK	COUNTRY BLUE	CU	NX LINEN	LN	*RUSTIC COPPER	M2	WICKER	WI
BRONZE	BZ	DESERT SAND	DS	LINEN	LI	SAGE	SA	30 WHITE	WH
BROOKSTONE	BS	EGG SHELL	ES	MONTANA SUEDE	MS	NX SAND STONE	SS	80 WHITE	80
BUCKSKIN	BU			MUSKET BROWN	MB	SANDTONE	ST		

\*Rustic Copper is a PREMIUM color. NOTE: Rustic Copper (M2) accessories, including miters and end caps, may display paint finish variations due to the metallic painting process, which may affect matching components.



# NORANDEX™ Hangers

APOLLO BEACH PLANT

Hidden Hangers		Part #	Description	Colors	Nominal Thickness	Piece Length	Pieces/Box
AHH5ML		AHH5ML	Aluminum 5" Hook Hanger with Clip	Mill	0.060	4-7/8"	500
		AHH51ML	Aluminum 5" Hook Hanger with Clip	Mill	0.060	4-7/8"	100
		AHT5CML	Aluminum 5" Hangtite Hanger with Clip	Mill	0.060	5"	1000
		AHHWF5ML	Aluminum 5" Flanged Hanger with Clip	Mill	0.060	5"	250
		AHH5NHML	Aluminum 5" Hook Hanger without Hole	Mill	0.060	5"	500
ABH5ML		ABH5ML	Aluminum 5" Backless Std. Bar Hanger	Mill	0.060	5-1/16"	400
		AHU51ML	Aluminum 5" Ultra Hanger without Clip	Mill	0.048	5"	100
		AHU5ML	Aluminum 5" Ultra Hanger without Clip	Mill	0.048	5"	1000
AHHWF5ML		AHU51CML	Aluminum 5" Ultra Hanger with Clip	Mill	0.048	5"	100
		AHU5CML	Aluminum 5" Ultra Hanger with Clip	Mill	0.048	5"	1000
		AHH6ML	Aluminum 6" Hook Hanger with Clip	Mill	0.060	6"	250
ABH5ML		AHHK6ML	Aluminum 6" Keg Hanger with Clip	Mill	0.060	6"	2500
		AHT6CML	Aluminum 6" Hangtite Hanger with Clip	Mill	0.060	6"	1000
		AHHWF6ML	Aluminum 6" Flanged Hanger with Clip	Mill	0.060	6"	250
BH6		ABH6ML	Aluminum 6" Backless Std. Bar Hanger	Mill	0.060	6-1/16"	750
		AHU61ML	Aluminum 6" Ultra Hanger without Clip	Mill	0.048	6"	100
		AHU6ML	Aluminum 6" Ultra Hanger without Clip	Mill	0.048	6"	1000
		AHU61CML	Aluminum 6" Ultra Hanger with Clip	Mill	0.048	6"	100
		AHU6CML	Aluminum 6" Ultra Hanger with Clip	Mill	0.048	6"	800
		BH6	Brass 6" Hanger with Clip	Brass	0.115	6-3/16"	150

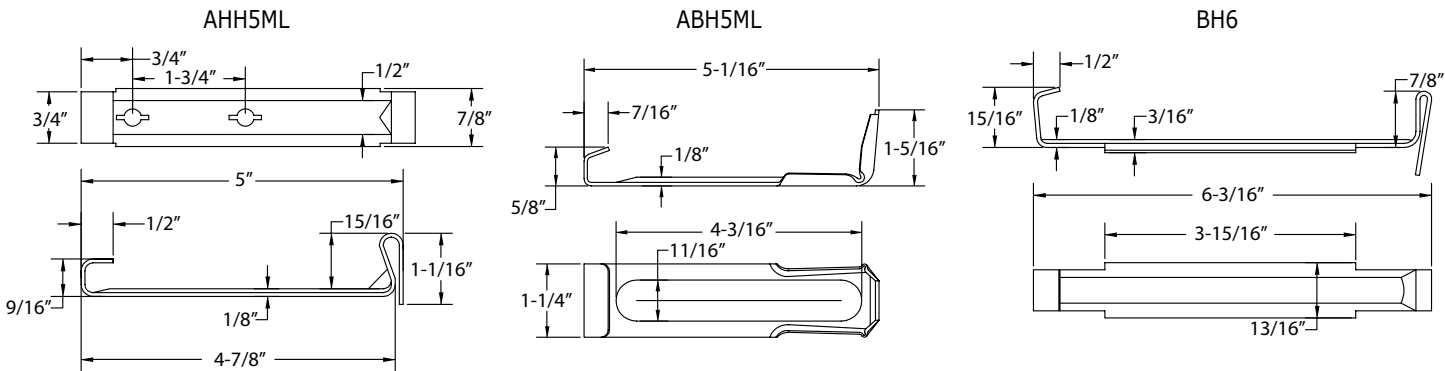

Wrap Around Hangers		Part #	Description	Colors	Nominal Thickness	Piece Length	Pieces/Box
		AWAH5 - -	Aluminum 5" Wrap Around Hanger	RB, WH, 80	0.060	16-3/4"	100
		AWAH6 - -	Aluminum 6" Wrap Around Hanger	WH	0.060	20-1/4"	50

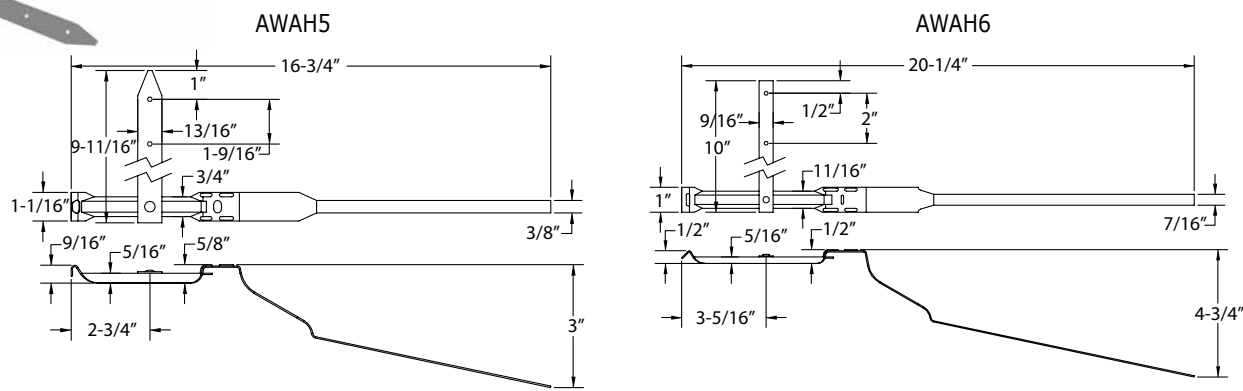

### Rainware & Accessories Colors

COLOR	CODE	COLOR	CODE	COLOR	CODE
ROYAL BROWN	RB	WHITE	WH	80 WHITE	80

\*Rustic Copper is a PREMIUM color.



# NORANDEX™ Hangers & Rainware Accessories APOLLO BEACH PLANT

T-Bar Hangers		Part #	Description	Colors	Nominal Thickness	Piece Length	Pieces/ Bag	Pieces/ Box
	ATBH5ML	Aluminum 5" T-Bar Strap Hanger w/Clip	Mill	0.060	12-1/2"	N/A	100	
	ATS5ML	Alum. 5/8" T-Bar Strap only	Mill	0.032	9-7/8"	100	2000	

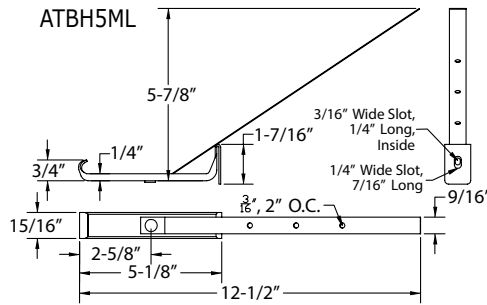

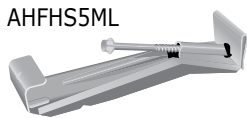

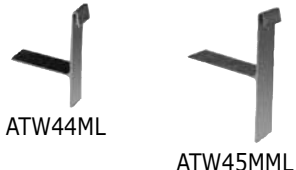
Hangers with Screws		Part #	Description	Colors	Nominal Thickness	Piece Length	Pieces/ Box
	AHFHS5ML	Alum. 5" Quick Screw Hidden Hgr w/Screw	Mill	0.060	5"	500	
	AHFHS6ML	Alum. 6" Quick Screw Hidden Hgr w/Screw	Mill	0.060	6"	300	
	AHUTS5CML	Alum. 5" Ultimate Hidden Hanger w/Screw & Clip	Mill	0.061	5"	400	
	AHUTS6CML	Alum. 6" Ultimate Hidden Hanger w/Screw & Clip	Mill	0.061	6"	300	
	AHFHS7ML	Alum. 7" Quick Screw Hidden Hgr w/Screw	Mill	0.060	7"	200	
	BHFHS5	Brass 5" Hang Fast w/Screw	Brass	0.115	5"	Order by the pc.	

T-Wedge		Part #	Description	Colors	Nominal Thickness	Pieces/ Bag
	ATW44ML	Aluminum 5" T-Wedge 4400	Mill	0.070	50	
	ATW45MML	Aluminum 5"-6" T-Wedge 4500	Mill	0.070	50	
	ATWHR49ML	Aluminum 6" Half Round T-Wedge 4900	Mill	0.070	50	

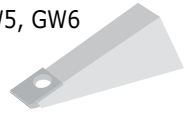
*A T-Wedge can be adjusted to keep the gutter level at various fascia board angles.*

Gutter Wedges		Part #	Description	Colors	Nominal Thickness	Pieces/ Box
	GW5 - -	Aluminum 5" Gutter Wedge	RB, WH	0.027	100	
	GW6 - -	Aluminum 6" Gutter Wedge	RB, WH	0.027	50	

Spikes		Part #	Description	Colors	Piece Length	Pieces/ Box
	AS7WH	Aluminum 7" Painted Spike	WH	7"	500	
	AS8WH	Aluminum 8" Painted Spike	WH	8"	500	
	AS8ML	Aluminum 8" Spike	Mill	8"	500	

Ferrules		Part #	Description	Colors	Piece Length	Pieces/ Box
	AF5ML	Aluminum 5" Ferrule	Mill	5"	500	
	AF6ML	Aluminum 6" Ferrule	Mill	6"	500	

### Rainware & Accessories Colors

COLOR	CODE	COLOR	CODE
ROYAL BROWN	RB	WHITE	WH





# NORANDEX™ Round & Half Round Products APOLLO BEACH PLANT

## Half Round Gutters

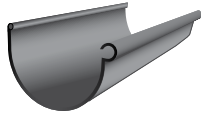

Part #	Description	Colors	Nominal Thickness	Piece Length	Pieces/Box	Boxes/Pallet
AGUH610 - -	Alum. 6" Reverse Bead 10' Sections	(Listed Below)	0.027	10'	5	16
AGUH610M2	Alum. 6" Reverse Bead 10' Sections	M2 (Premium Color)	0.027	10'	5	16
AGUH620 - -	Alum. 6" Reverse Bead 20' Sections	(Listed Below)	0.027	20'	5	16
AGUH620M2	Alum. 6" Reverse Bead 20' Sections	M2 (Premium Color)	0.027	20'	5	16
LGUH610	Glum. 6" Reverse Bead 10' Sections	Mill	26 ga	10'	5	16
LGUH620	Glum. 6" Reverse Bead 20' Sections	Mill	26 ga	20'	5	16
CGUH610	Copper 6" Reverse Bead 10' Sections	Copper	16 oz	10'	5	
CGUH620	Copper 6" Reverse Bead 20' Sections	Copper	16 oz	20'	5	

**Sold in 5-count cartons only.**

## Round Downspouts



Part #	Description	Colors	Nominal Thickness	Piece Length	Pieces/Box	Boxes/Pallet
ADSR310 - -	Alum. 3" Round x 10', Smooth	(Listed Below)	0.019	10'	5	30
ADSR310M2	Alum. 3" Round x 10', Smooth	M2 (Premium Color)	0.019	10'	5	30
ADSR410 - -	Alum. 4" Round x 10', Smooth	(Listed Below)	0.019	10'	5	20
ADSR410M2	Alum. 4" Round x 10', Smooth	M2 (Premium Color)	0.019	10'	5	20
GDSR410 - -	Galv. 4" Round x 10'	(Listed Below)	26 ga	10'	5	30
GDSR410ML	Galv. 4" Round x 10'	Mill	26 ga	10'	5	30
LDSR310	Glum. 3" Round x 10', Plain	Mill	26 ga	10'	5	28
LDSR410	Glum. 4" Round x 10', Plain	Mill	26 ga	10'	5	28
CDSR310	Copper 3" Round x 10', Smooth	Copper	16 oz	10'	Order by the pc.	
CDSR410	Copper 4" Round x 10', Smooth	Copper	16 oz	10'	Order by the pc.	

## Rainware & Accessories Aluminum Colors

COLOR	CODE	COLOR	CODE	COLOR	CODE	COLOR	CODE
ALMOND	AL	CAMEO	CA	MUSKET BROWN	MB	RUSTIC COPPER	M2
BEAVER BROWN	BB	CHARCOAL GREY	CG	PEBBLESTONE CLAY	PC	SANDTONE	ST
BLACK	BK	CLASSIC CREAM	CC	PG METALLIC	M3	NX SIERRA CLAY	SI
BRONZE	BZ	COPPER PENNY	CP	ROYAL BROWN	RB	TERRA BRONZE	TB
BUCKSKIN	BU	HARBOR GREY	HG			VICTORIAN GREY	VG
						WICKER	WI
						30 WHITE	WH
						80 WHITE	80

■ Stocked half-round colors. Balance of colors available with extended lead-time.

\*Rustic Copper is a PREMIUM color. NOTE: Rustic Copper (M2) accessories, including miters and end caps, may display paint finish variations due to the metallic painting process, which may affect matching components.

## Rainware Steel Colors:

COLOR	CODE	COLOR	CODE	COLOR	CODE	COLOR	CODE
BEAVER BROWN	BB	CLASSIC CREAM	CC	EVERGREEN	EG	PEBBLESTONE CLAY	PC
BLACK	BK	COUNTRY BLUE	CU	HARBOR GREY	HG	PRIME	PR
BRONZE	BZ	DESERT SAND	DS	HARVEST BROWN	HV	REDWOOD	RW
CHARCOAL GREY	CG	EGGSHELL	ES	MUSKET BROWN	MB	ROYAL BROWN	RB
						TAHOE BLUE	TA
						VICTORIAN GREY	VG
						WICKER	WI
						30 WHITE	WH



## Round Elbows

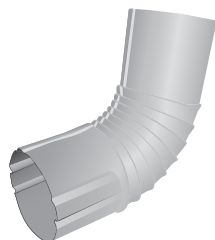

Part #	Description	Colors	Nominal Thickness	Pieces/Box	Boxes/Pallet
AER3 - -	Alum. 3" Round 75°	(Listed Below)	0.019	30	16
AER3M2	Alum. 3" Round 75°	M2 (Premium Color)	0.019	30	16
AER4 - -	Alum. 4" Round 75°	(Listed Below)	0.019	30	16
AER4M2	Alum. 4" Round 75°	M2 (Premium Color)	0.019	30	16
GER430ML	Galv. 4" Round 30°	Mill	26 ga	20	24
GER445 - -	Galv. 4" Round 45°	(Listed Below)	26 ga	20	24
GER445ML	Galv. 4" Round 45°	Mill	26 ga	20	24
GER475 - -	Galv. 4" Round 75°	(Listed Below)	26 ga	20	24
GER475ML	Galv. 4" Round 75°	Mill	26 ga	20	24
LER3	Glum. 3" Round 75°	Mill	26 ga	10	32
LER445	Glum. 4" Round 45°	Mill	26 ga	10	32
LER4	Glum. 4" Round 75°	Mill	26 ga	10	32
CER330	Copper 3" Round 30°	Copper	16 oz	Order by the pc.	
CER3	Copper 3" Round 75°	Copper	16 oz	Order by the pc.	
CER430	Copper 4" Round 30°	Copper	16 oz	Order by the pc.	
CER4	Copper 4" Round 75°	Copper	16 oz	Order by the pc.	

## Round Offsets



Part #	Description	Colors	Nominal Thickness	Pieces/Box
ABO12R3 - -	Aluminum 2" Offset 3" Round	(Listed Below)	0.019	20
ABO12R3M2	Aluminum 2" Offset 3" Round	M2 (Premium Color)	0.019	20
ABO14R3 - -	Aluminum 4" Offset 3" Round	(Listed Below)	0.019	20
ABO14R3M2	Aluminum 4" Offset 3" Round	M2 (Premium Color)	0.019	20
ABO12R4 - -	Aluminum 2" Offset 4" Round	(Listed Below)	0.019	20
ABO12R4M2	Aluminum 2" Offset 4" Round	M2 (Premium Color)	0.019	20
ABO14R4 - -	Aluminum 4" Offset 4" Round	(Listed Below)	0.019	20
ABO14R4M2	Aluminum 4" Offset 4" Round	M2 (Premium Color)	0.019	20
ABO16R4 - -	Aluminum 6" Offset 4" Round	(Listed Below)	0.019	20
CBO12R3	Copper 2" Offset 3" Round	Copper	16 oz	Order by the pc.
CBO14R3	Copper 4" Offset 3" Round	Copper	16 oz	Order by the pc.
CBO12R4	Copper 2" Offset 4" Round	Copper	16 oz	Order by the pc.
CBO14R4	Copper 4" Offset 4" Round	Copper	16 oz	Order by the pc.
CBO16R4	Copper 6" Offset 4" Round	Copper	16 oz	Order by the pc.

## Rainware & Accessories Aluminum Colors

COLOR	CODE	COLOR	CODE	COLOR	CODE	COLOR	CODE	COLOR	CODE
ALMOND	AL	CAMEO	CA	■ MUSKET BROWN	MB	★ ■ RUSTIC COPPER	M2	VICTORIAN GREY	VG
BEAVER BROWN	BB	CHARCOAL GREY	CG	■ PEBBLESTONE CLAY	PC	■ SANDTONE	ST	WICKER	WI
BLACK	BK	CLASSIC CREAM	CC	■ PG METALLIC	M3	■ NX SIERRA CLAY	SI	■ 30 WHITE	WH
■ BRONZE	BZ	■ COPPER PENNY	CP	■ ROYAL BROWN	RB	■ TERRA BRONZE	TB	80 WHITE	80
BUCKSKIN	BU	HARBOR GREY	HG						

■ Stocked half-round colors. Balance of colors available with extended lead-time.

★ Rustic Copper is a PREMIUM color. NOTE: Rustic Copper (M2) accessories, including miters and end caps, may display paint finish variations due to the metallic painting process, which may affect matching components.

## Rainware Steel Colors:

COLOR	CODE	COLOR	CODE	COLOR	CODE	COLOR	CODE	COLOR	CODE
BEAVER BROWN	BB	CLASSIC CREAM	CC	EVERGREEN	EG	PEBBLESTONE CLAY	PC	TAHOE BLUE	TA
BLACK	BK	COUNTRY BLUE	CU	HARBOR GREY	HG	PRIME	PR	VICTORIAN GREY	VG
BRONZE	BZ	DESERT SAND	DS	HARVEST BROWN	HV	REDWOOD	RW	WICKER	WI
CHARCOAL GREY	CG	EGGSHELL	ES	MUSKET BROWN	MB	ROYAL BROWN	RB	30 WHITE	WH



# NORANDEX™ Half Round Products

APOLLO BEACH PLANT

## Half Round Outlets

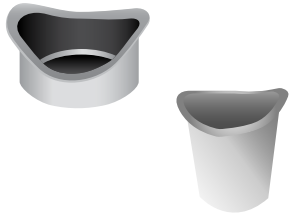

Part #	Description	Colors	Nominal Thickness	Pieces/Box
AOROH63ML	Aluminum 3" Round x 6" HR Outlet	*	0.019	50
AOROH64ML	Aluminum 4" Round x 6" HR Outlet	*	0.019	50
GOROH63	Galvanized 3" Round x 6" HR Outlet	*	26 ga	Order by the pc.
GOROH64	Galvanized 4" Round x 6" HR Outlet	*	26 ga	Order by the pc.
COROH63	Copper 3" Round x 6" HR Outlet	Copper	16 oz	Order by the pc.
COROH64	Copper 4" Round x 6" HR Outlet	Copper	16 oz	Order by the pc.

\*NOTE: Aluminum outlets made with mill or painted finish per manufacturer's discretion.

## Half Round Miters

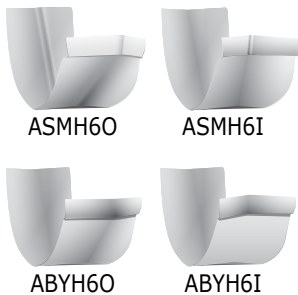

Part #	Description	Colors	Nominal Thickness	Pieces/Box
ASM H6I - -	Aluminum 6" 90°, Strip, Inside	(Listed Below)	0.027	20
ASM H6I M2	Aluminum 6" 90°, Strip, Inside	M2 (Premium Color)	0.027	20
ASM H6O - -	Aluminum 6" 90°, Strip, Outside	(Listed Below)	0.027	20
ASM H6O M2	Aluminum 6" 90°, Strip, Outside	M2 (Premium Color)	0.027	20
ABY H6I - -	Aluminum 6" 45°, Bay, Inside	(Listed Below)	0.027	20
ABY H6I M2	Aluminum 6" 45°, Bay, Inside	M2 (Premium Color)	0.027	20
ABY H6O - -	Aluminum 6" 45°, Bay, Outside	(Listed Below)	0.027	20
ABY H6O M2	Aluminum 6" 45°, Bay, Outside	M2 (Premium Color)	0.027	20
LSM H6I	Galvalume 6" 90°, Strip, Inside	Mill	26 ga	20
LSM H6O	Galvalume 6" 90°, Strip, Outside	Mill	26 ga	20
CSM H6I	Copper 6" 90°, Strip, Inside	Copper	16 oz	20
CSM H6O	Copper 6" 90°, Strip, Outside	Copper	16 oz	20

## Half Round Slip Joints



Part #	Description	Colors	Nominal Thickness	Pieces/Box
ASJCH6WH	Aluminum 6" HR Slip Joint	WH	0.019	Order by the pc.
LSJCH6WH	Galvalume 6" HR Slip Joint	WH	26 ga	Order by the pc.

## Half Round End Caps

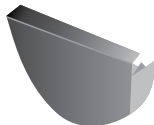

Part #	Description	Colors	Nominal Thickness	Pieces/Box
AECH6 - -	Aluminum 6" HR Universal End Cap	(Listed Below)	0.019	20
AECH6M2	Aluminum 6" HR Universal End Cap	M2 (Premium Color)	0.019	20
LECH6	Galvalume 6" HR Universal End Cap	Mill	26 ga	20
CECH6	Copper 6" HR Universal End Cap	Copper	16 oz	20

## Rainware & Accessories Aluminum Colors

COLOR	CODE	COLOR	CODE	COLOR	CODE	COLOR	CODE	COLOR	CODE
ALMOND	AL	BUCKSKIN	BU	HARBOR GREY	HG	* ■ RUSTIC COPPER	M2	VICTORIAN GREY	VG
ANTIQUE IVORY	AI	CAMEO	CA	■ MUSKET BROWN	MB	SANDTONE	ST	WICKER	WI
BEAVER BROWN	BB	CHARCOAL GREY	CG	PEBBLESTONE CLAY	PC	NX SIERRA CLAY	SI	■ 30 WHITE	WH
BLACK	BK	CLASSIC CREAM	CC	PG METALLIC	M3	TERRA BRONZE	TB	80 WHITE	80
■ BRONZE	BZ	■ COPPER PENNY	CP	ROYAL BROWN	RB				



■ Stocked half-round colors. Balance of colors available with extended lead-time.

\*Rustic Copper is a PREMIUM color. NOTE: Rustic Copper (M2) accessories, including miters and end caps, may display paint finish variations due to the metallic painting process, which may affect matching components.



# NORANDEX™ Half Round Products

APOLLO BEACH PLANT

Half Round Brackets		Part #	Description	Colors	Pieces/Box
	ACC10H6	ACC10H6 - -	Aluminum 6" HR Combo Cir/Shk w/Clip Hanger	BZ, MB, WH, 80	Order by the pc.
		ACC10H6ML	Aluminum 6" HR Combo Cir/Shk w/Clip Hanger	Mill	Order by the pc.
	AHRFH6	AHRFH6 - -	Aluminum 6" HR Fascia Hanger	BK, BZ, MB, WH	Order by the pc.
		GCC10H6	Galvanized 6" HR Combo Cir/Shk w/Clip Hanger	Mill	Order by the pc.
	LHRFH6	Galvalume 6" HR Fascia Hanger	Mill	Order by the pc.	
	CCC10H6	Copper 6" HR Combo Cir/Shk w/Clip Hanger	Copper	Order by the pc.	
	CHRFH6	Copper 6" HR Fascia Hanger	Copper	25	

Half Round Hidden Hangers		Part #	Description	Colors	Pieces/Box
	AHHHR6ML	AHHHR6ML	Aluminum 6" HR Hook Hanger	Mill	100
	AHHSR6ML	AHHSR6ML	Aluminum 6" HR Hidden Clip Hanger w/Screw	Mill	100
		SHHHR6ML	Stainless Steel 6" HR Hook Hanger	Mill	100

**Note: Only for reverse bead half round gutters**

Half Round T-Wedge Hangers		Part #	Description	Colors	Nominal Thickness	Pieces/Bag
	ATWHR49ML	ATWHR49ML	Aluminum HR T-Wedge 4900	Mill	0.070	50
		A T-Wedge can be adjusted to keep the gutter level at various fascia board angles.				

**Rainware Aluminum Colors:**

COLOR	CODE	COLOR	CODE	COLOR	CODE	COLOR	CODE	COLOR	CODE
BLACK	BK	BRONZE	BZ	MUSKET BROWN	MB	WHITE	WH	80 WHITE	80



# NORANDEX™ Gutter Protection

APOLLO BEACH PLANT

## Screen Systems

Part #	Description	Color	Nom. Gauge/ Thickness	Piece Length	Pieces/ Box	Feet/ Box
--------	-------------	-------	--------------------------	-----------------	----------------	--------------



### NX Premium Stainless Steel Micro Mesh

**The ultimate in gutter protection!** This tightly woven, heavy gauge stainless steel micro mesh gutter guard, with its corrosion-resistant properties, is a significant debris deterrent. It installs easily under the shingles and fastens to the front gutter hem with provided screws, while self-adjusting to various roof pitches.

ALGP5SPML	5" Premium SS Micro Mesh	Mill	14 ga	4'	25	100'
ALGP6SPML	6" Premium SS Micro Mesh	Mill	14 ga	4'	25	100'
ALMMMI56ML	Stainless Steel Mesh Inside Corner 5/6"	Mill	14 ga	-	3	-

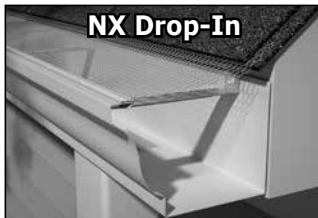

### NX Drop-In

The front attachment provides a firm hold to the front of the gutter and has a wide mounting flange for a permanent install. The mill finish aluminum screen is micro crimped for enhanced durability.

ALGP5DIML	Aluminum 5" Drop-In	Mill	0.025	4'	50	200'
ALGP6DIML	Aluminum 6" Drop-In	Mill	0.025	4'	50	200'



### NX Lock Small Hole

The small hole screen system installs quickly without disturbing the shingles with its front and back snap lock system.

GGP5LSHBK	Galvanized 5" Lock Small Hole	BK	28 ga	4'	25	100'
GGP6LSHBK	Galvanized 6" Lock Small Hole	BK	28 ga	4'	25	100'
GGP7LSHBK	Galvanized 7" Lock Small Hole	BK	28 ga	4'	25	100'



### NX Lock Regular Hole

The regular hole screen system installs quickly without disturbing the shingles with its front and back snap lock system.

GGP5LRHBK	Galvanized 5" Lock Regular Hole	BK	28 ga	4'	25	100'
GGP6LRHBK	Galvanized 6" Lock Regular Hole	BK	28 ga	4'	25	100'



### NX Step Down

The small hole screen incorporates a raised snap-in system in the back of the gutter to seal off the void between the shingles and the screen. Step Down installs quickly without the use of screws or disturbing the shingles.

GGP5SDBK	Galvanized 5" Step Down	BK	28 ga	4'	25	100'
GGP6SDBK	Galvanized 6" Step Down	BK	28 ga	4'	25	100'



### NX Premium Lock

The tiny holes keeps out small debris, while allowing water to flow through the screen. Two stiffening beads run down the center of the screen for added strength. Installation is quick and easy without disturbing the shingles. The screen locks into place with a raised back and front-tiered mounting system.

ALGP5PLBK	Aluminum 5" Premium Lock (screen tiny holes)	BK	0.032	4'	25	100'
ALGP6PLBK	Aluminum 6" Premium Lock (screen tiny holes)	BK	0.032	4'	25	100'



### NX Deluxe Half Round

Spring tension design holds this gutter screen in place. Snaps in and out of half round gutters for easy cleaning. 28 gauge steel stands tough under a full load of wet leaves without collapsing. Installs with a slope toward the front to help debris slide off.

GLGEZ6DH	Galvanized 6.5" Deluxe Half Round	BK	28 ga	4'	25	100'
----------	-----------------------------------	----	-------	----	----	------

### Gutter Screen System Color:

COLOR	CODE	COLOR	CODE
BLACK	BK	MILL	ML



## Perforated & Dome

Part #	Description	Colors	Nominal Thickness	Piece Length	Pieces/Box	Feet/Box
--------	-------------	--------	-------------------	--------------	------------	----------



**NX SMOOTH FLOW**

### NX Smooth Flow

The perforated cover installs easily without disturbing the shingles. Product is factory notched for easy overlapping. Dual center ribbed bends provide extra rigidity against expansion and contraction. Six 50-count bags of #6 hex head 3/8 stainless steel painted screws are included.

ALGP5SF - -	5" Smooth Flow	BK, WH	0.019	6'	40	240'
ALGP5SFML	5" Smooth Flow	Mill	0.019	6'	40	240'
ALGP510SF -	5" Smooth Flow	B, W	0.019	10'	25	250'
ALGP510SFM	5" Smooth Flow	Mill	0.019	10'	25	250'
ALGP6SF - -	6" Smooth Flow	BK, WH	0.019	6'	40	240'
ALGP6SFML	6" Smooth Flow	Mill	0.019	6'	40	240'
ALGP610SF - -	6" Smooth Flow	B, W	0.019	10'	25	250'
ALGP610SFM	6" Smooth Flow	Mill	0.019	10'	25	250'



**NX MASTER FLOW**

### NX Master Flow

The snap in perforated panels are installed without disturbing the shingles and without the use of screws. The patented curved back portion keeps the contoured front mounting system in place, provides a gentle transition of rainwater on to the panel, blocks debris from depositing in the back of the gutter, and is not obstructed by screw hangers.

ALGP5MFBK	Aluminum 5" Master Flow	BK	0.019	4'	25	100'
ALGP6MFBK	Aluminum 6" Master Flow	BK	0.019	4'	25	100'



**NX SNAP-IN DOME**

### NX Snap-In Dome Cover

This unique solid dome cover is designed for maximum debris load and is one of the easiest dome cover systems to install. The dome cover snaps in without the use of brackets or screws and doesn't disturb the shingles. Snap-In Dome is available in several colors to enhance the curb appeal of your home by blending in with the roof line.

ALGP5SD - -	Aluminum 5" Snap-In Dome	BK, RB, TB, WH	0.028	4'	14	56'
ALGP6SD - -	Aluminum 6" Snap-In Dome	BK, RB, TB, WH	0.028	4'	14	56'



**NX INSIDE MITER KIT**

### NX Inside Miter Kit

A5SDIMK - -	Alum. 5" 1 Rt Panel, 1 Lft Panel & 4' Rain Diverter	BK, RB, TB, WH	0.027	4'	1 pair/box	
A6SDIMK - -	Alum. 6" 1 Rt Panel, 1 Lft Panel & 4' Rain Diverter	BK, RB, TB, WH	0.027	4'	1 pair/box	



**NX OUTSIDE MITER KIT**

### NX Outside Miter Kit

A5SDOMK - -	Aluminum 5" 1 Right Panel & 1 Left Panel	BK, RB, TB, WH	0.027	4'	1 pair/box	
A6SDOMK - -	Aluminum 6" 1 Right Panel & 1 Left Panel	BK, RB, TB, WH	0.027	4'	1 pair/box	



**NX UNIVERSAL END CAP**

### NX Universal End Caps

A5SDUEC - -	Aluminum 5" Universal End Caps	BK, RB, TB, WH	0.019		10/Bag	
A6SDUEC - -	Aluminum 6" Universal End Caps	BK, RB, TB, WH	0.019		10/Bag	

NOTE: All products and colors may not be available in specific supply centers. Contact your Territory Manager for local availability.

### Gutter Protection Colors:

COLOR	CODE	COLOR	CODE	COLOR	CODE	COLOR	CODE	COLOR	CODE
BLACK	BK	ROYAL BROWN	RB	TERRA BRONZE	TB	WHITE		MILL	ML

# Gutter Protection

APOLLO BEACH PLANT

## Gutter Protection

Part #	Description	Colors	Nominal Thickness	Piece Length	Pieces/Box
<b>Gutter Protection</b>					
ALGLFH55 - -	Aluminum 5"/6" Perforated High-Flow Gutter Cover with Screws 4'	AL, BK, CC, DB, EG, IV, MB, PL, RB, S1, TB, TX, WH	0.024	4'	25
ALGLFS5 - -	Aluminum 5"/6" Standard Solid Gutter Cover with Screws 4'	AL, BK, CC, DB, EG, IV, MB, PL, RB, Si, TB, TX, WH	0.024	4'	25
ALGRX5 - -	Aluminum 5" Drop-In Cover 6'	DB, WH	0.019	6'	50
ALGRX6 - -	Aluminum 6" Drop-In Cover 6'	DB, WH	0.019	6'	50
ALGRX7 - -	Aluminum 7" Drop-In Cover 6'	DB, WH	0.019	6'	50
ALGP5CS - -	Aluminum 5" Clean Sweep 7-1/2'	BK, WH	0.019	7-1/2'	40
ALGP6CS - -	Aluminum 6" Clean Sweep 7-1/2'	BK, WH	0.019	7-1/2'	40



ALGLFH55 Perforated High-Flow



ALGLFS5 Solid



ALGRX5 Drop-In



ALGP5CSWH Clean Sweep

## Gutter Protection Accessories

ALGLFM5 - -	Miters (set - 1 Left & 1 Right)	AL, BK, CC, DB, EG, IV, MB, PL, RB, Si, TB, TX, WH	0.024		10
ALGLFE5R - -	End Caps (Right)	AL, BK, CC, DB, EG, IV, MB, PL, RB, Si, TB, TX, WH	0.024	5"	25
ALGLFE5L - -	End Caps (Left)	AL, BK, CC, DB, EG, IV, MB, PL, RB, Si, TB, TX, WH	0.024	5"	25

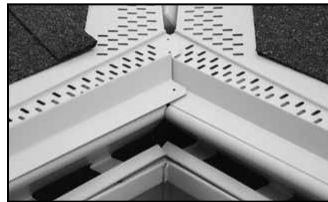

ALGLFM5 Miters



ALGLFE5 R/L End Caps

## Gutter Protection Colors:

COLOR	CODE	COLOR	CODE	COLOR	CODE	COLOR	CODE	COLOR	CODE
ALMOND	AL	CLAY	CL	IVORY	IV	ROYAL BROWN	RB	TUXEDO GRAY	TX
BLACK	BK	DARK BRONZE	DB	MUSKET BROWN	MB	SAND	S1	30 WHITE	WH
CLASSIC CREAM	CC	EVERGREEN	EG	PEARL GRAY	PL	TERRA BRONZE	TB		

# Aluminum TRIM COIL Color Selection

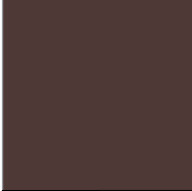

→ Printed Color Swatch (for color accuracy you need actual metal)

Color -Thru  Offering select products in comparable matching colors through gutter coil, rainware, soffit/fascia, trim coil or edge metal product lines

PVC Also Available in PVC

Color -Thru PVC  
**Royal Brown**  
 B6 / RB

→ Trim Coil Color Code / Comparable Rainware Color Code  
 Add trim coil code at end of smooth, woodgrain or PVC prefix for complete part number

Description	All Colors		Limited
	Smooth	Woodgrain	PVC
Part #	ATCS24--	ATCW24--	ATCP24--





Color-Thru PVC

**WHITE**  
W1 / WH

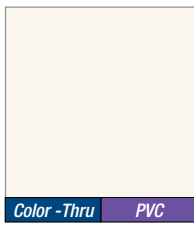

Color-Thru PVC

**LINEN**  
W10 / LN

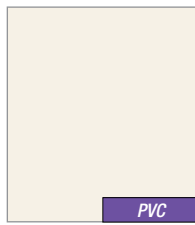

PVC

**BEIGE**  
D52

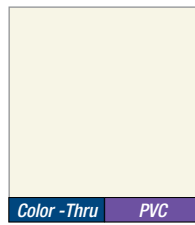

Color-Thru PVC

**ALMOND**  
D49 / AD



Color-Thru PVC

**TAN**  
D48 / TN

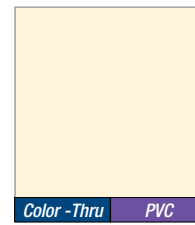

Color-Thru PVC

**CREAM**  
D22 / CC



**YELLOW**  
Y4

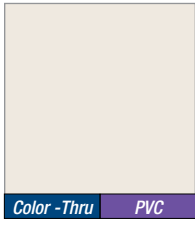

Color-Thru PVC

**CHAMPAGNE**  
D53 / CH

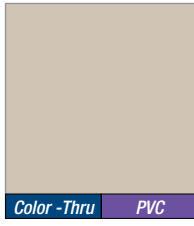

Color-Thru PVC

**SAND**  
D51 / SD

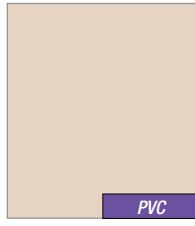

PVC

**WHEAT**  
D50

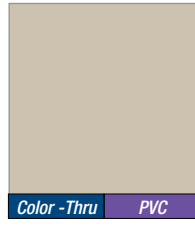

Color-Thru PVC

**SAND STONE**  
D46 / SS

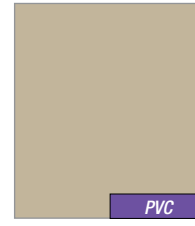

PVC

**TUMBLEWEED TAN**  
D55



Color-Thru

**NORWEGIAN WOOD**  
D26 / NW



PVC

**COBBLESTONE CLAY**  
D56



Color-Thru PVC

**SIERRA CLAY**  
D47 / Si



**KHAKI**  
D59



PVC

**MOCHA**  
D58

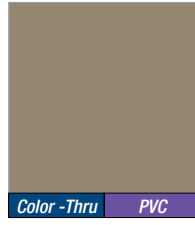

Color-Thru PVC

**RUSSET**  
B18 / RT



PVC

**MAVERICK BROWN**  
B20

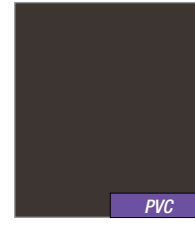

PVC

**CARBON**  
A29



PVC

**BRONZE**  
B13



**RUSTIC CEDAR**  
D65

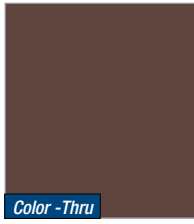

Color-Thru

**BEAVER BROWN**  
B5 / BB

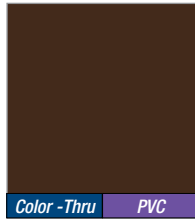

Color-Thru PVC

**MUSKET BROWN**  
B1 / MB

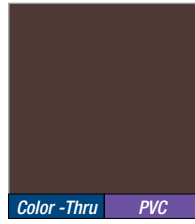

Color-Thru PVC

**ROYAL BROWN**  
B6 / RB



PVC

**FIREBRICK**  
R6



PVC

**GRAPHITE**  
A25



PVC

**VINTAGE GREY**  
A9

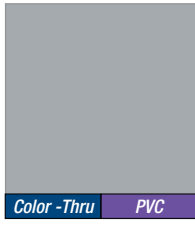

Color-Thru PVC

**GRANITE**  
A19 / GG

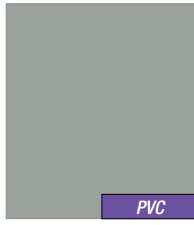

PVC

**SMOKE**  
A21

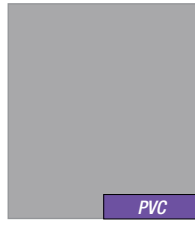

PVC

**DOVE GRAY**  
A26

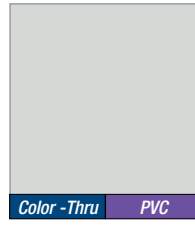

Color-Thru PVC

**SILVER GRAY**  
A3 / SG

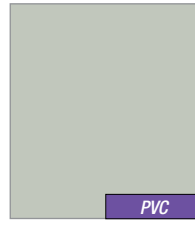

PVC

**CACTUS**  
G16



PVC

**FERN**  
A24



PVC

**IVY GREEN**  
G13

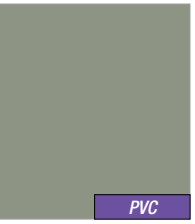

PVC

**OLIVE**  
G14



**ACADIA GREEN**  
G19

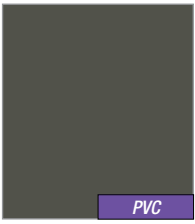

PVC

**MYRTLE**  
G17

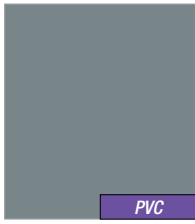

PVC

**SEAPORT**  
A22

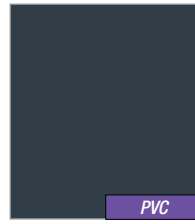

PVC

**DEEP WATER**  
L10



PVC

**JAMESTOWN BLUE**  
L2

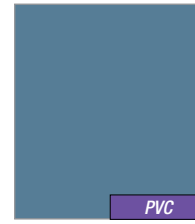

PVC

**STEEL BLUE**  
L8

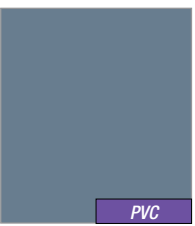

PVC

**GENEVA BLUE**  
L9

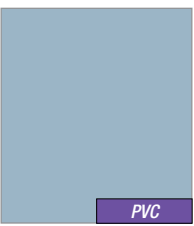

PVC

**WEDGEWOOD BLUE**  
L7

*Note: Actual color may vary from this representation. Please refer to actual metal color swatches for color accuracy. Color appearance may change when viewed at different angles or in sunlight.*

**SHERWIN-WILLIAMS**  
Coil Coatings



**NORANDEX**<sup>™</sup>

EXTERIOR PRODUCTS FOR YOUR HOME

Aluminum **TRIM COIL** Color Selection

# Trim Coil Offering

APOLLO BEACH PLANT

Trim Coil	Description (Nominal Thickness)	Piece Length	Pieces/Box	Boxes/Pallet	Pieces/Pallet	Rolls/Truck
	.019 Aluminum Trim Coil	50'	1	48	48	1248

*Unless otherwise stated, all Smooth and Wood Grain trim coil is white (W1) on the opposite side.*

NORANDEX™	Smooth ATCS24 --	Woodgrain ATCW24T --	PVC ATCP24 --	Rainware Comparable
Acadia Green	G19	G19	N/A	N/A
Almond	D49	D49	D49	AD
Beaver Brown	B5	B5	N/A	BB
Beige	D52	D52	D52	N/A
Bronze	B13	B13	B13	N/A
Cactus	G16	G16	G16	N/A
Carbon	A29	A29	A29	N/A
Champagne	D53	D53	D53	CH
Cobblestone Clay	D56	D56	D56	N/A
Cream	D22	D22	D22	CC
Deep Water	L10	L10	L10	N/A
Dove Gray	A26	A26	A26	N/A
Dune	D54	D54	D54	CD
Fern	A24	A24	A24	N/A
Firebrick	R6	R6	R6	N/A
Geneva Blue	L9	L9	L9	N/A
Granite	A19	A19	A19	GG
Graphite	A25	A25	N/A	N/A
Ivy Green	G13	G13	G13	N/A
Jamestown Blue	L2	L2	L2	N/A
Linen	W10	W10	W10	LN
Maverick Brown	B20	B20	B20	N/A
Mocha	D58	D58	D58	N/A
Musket Brown	B1	B1	B1	MB
Myrtle	G17	G17	G17	N/A
Norwegian Wood	D26	D26	N/A	NW
Olive	G14	G14	G14	N/A
Royal Brown	B6	B6	B6	RB
Russet	B18	B18	B18	RT
Rustic Cedar	D65	D65	N/A	N/A
Sand	D51	D51	D51	SD
Sand Stone	D46	D46	D46	SS
Seaport	A22	A22	A22	N/A
Sierra	D47	D47	D47	SI
Silver	A3	A3	A3	SG
Smoke	A21	A21	A21	N/A
Steel Blue	L8	L8	L8	N/A
Tan	D48	D48	D48	TN
Tumbleweed Tan	D55	D55	D55	N/A
Vintage Grey	A9	A9	A9	N/A
Wedgewood Blue	L7	L7	L7	N/A
Wheat	D50	D50	D50	N/A
White	W1	W1	W1	WH
Yellow	Y4	Y4	N/A	N/A

TEXTURED	Textured ATCT24 --	<i>NOTE: Textured Trim Coil is painted white on reverse side.</i>
Clay	D39	
Tan	D38	
White	W4	

MASTIC	Smooth ATCS24 --	Woodgrain ATCW24T --	PVC ATCP24 --	Rainware Comparable
Almond	D14	D14	D14	AL
Alpine Forest (Solar Def.)	C7	C7	N/A	N/A
Black	A17	A17	A17	BK
Brookstone	D21	D21	N/A	BS
Cameo	W2	W2	W2	CA
Cape Cod Grey	A2	A2	A2	HG
Charcoal Grey	A8	A8	N/A	CG
Classic Cream	D22	D22	D22	CC
Dark Bronze	B13	B13	B13	N/A
Deep Granite	A9	A9	N/A	N/A
Desert Sand	D34	D34	D34	DS
English Wedgewood	A11	A11	N/A	N/A
Everest	A15	A15	N/A	EV
Evergreen	G6	G6	G6	EG
Harbor Grey	A2	A2	A2	HG
Lakeshore Fern	G2	G2	N/A	N/A
Linen	D4	D4	D4	LI
Montana Suede	D44	D44	D44	MS
Musket Brown	B1	B1	B1	MB
Natural Cedar	B9	B9	N/A	N/A
Natural Slate	A23	A23	N/A	N/A
Newport Bay	L2	L2	L2	N/A
Pebblestone Clay	D5	D5	D5	PC
Portsmouth Blue	L6	L6	N/A	N/A
Red Brick (Solar Def.)	R8	R8	N/A	N/A
Redwood	R3	R3	N/A	RW
Royal Brown	B6	B6	B6	RB
Rugged Canyon	B9	B9	N/A	N/A
Russet Red	R4	R4	N/A	N/A
Sandtone	D6	D6	D6	ST
Silver Grey	A3	A3	A3	SG
Terra Bronze	B12	B12	B12	TB
Victorian Grey	A5	A5	A5	VG
Vintage Brick	R1	R1	R1	N/A
Vintage Dublin	G17	G17	G17	N/A
White	W1	W1	W1	WH
Wicker	D8	D8	D8	WI
Whispering Timber	C5	C5	N/A	N/A
Woodland Retreat	A29	A29	A29	N/A

SPECIALTY COILS	Smooth Part #	Wood Grain Part #	Description	Piece Length	Nominal Thickness	Rolls/Pallet
Black/Royal Brown	ATCS14B14	ATCW14TB14	Alum. 14"	50'	0.019	48
Black/Royal Brown	ATCS24B14	ATCW24TB14	Alum. 24"	50'	0.019	48
Black/Royal Brown	ATCS224B14	ATCW224TB14	Alum. 24"	50'	0.024	32
Hickory Brown	ATCS24TB16	ATCW24TB16	Alum. 24"	50'	0.019	48
Mastic White	ATCS14W1	ATCW14TW1	Alum. 14"	50'	0.019	48
Mastic White	ATCS224W1	ATCW224TW1	Alum. 24"	50'	0.024	32
Mastic White	ATCS415W1	ATCW415TW1	Alum. 24"	150'	0.019	18

PROUDLY FINISHED WITH

**SHERWIN-WILLIAMS.**  
Coil Coatings

# Trim Coil Offering

APOLLO BEACH PLANT

Trim Coil	Description (Nominal Thickness)	Piece Length	Pieces/Box	Boxes/Pallet	Pieces/Pallet	Rolls/Truck
	.019 Aluminum Trim Coil	50'	1	48	48	1248

*Unless otherwise stated, all Smooth and Wood Grain trim coil is white (W1) on the opposite side.*

<b>CERTAINTEED</b>	Smooth ATCS24 --	Woodgrain ATCW24T --	PVC ATCP24 --	Rainware Comparable
Buckskin	D23	D23	N/A	N/A
Charcoal Grey	A9	A9	N/A	N/A
Cypress	G1	G1	G1	N/A
Desert Tan	D13	D13	D13	N/A
Flagstone	A12	A12	N/A	N/A
Granite Gray	A2	A2	A2	N/A
Heritage Cream	Y1	Y1	Y1	N/A
Light Maple	D12	D12	D12	N/A
Natural Clay	D47	D47	D47	SI
Oxford Blue	L1	L1	N/A	N/A
Sable Brown	B20	B20	B20	N/A

<b>EXTERIOR PORTFOLIO</b>	Smooth ATCS24 --	Woodgrain ATCW24 --	PVC ATCP24 --	Rainware Comparable
Aspen White	W1	W1	W1	WH
Bone	D37	D37	D37	N/A
Clay	D47	D47	D47	SI
Cypress	G1	G1	G1	N/A
Driftwood	A28	A28	A28	N/A
Espresso	B12	B12	B12	N/A
Greystone	A2	A2	A2	HG
Honey Oak	D23	D23	N/A	N/A
Ivory	D10	D10	D10	N/A
Lighthouse Red	R1	R1	R1	N/A
Metropolitan Gray	A9	A9	N/A	N/A
Mocha	D7	D7	D7	N/A
Oceanside	A22	A22	A22	N/A
Olive	G2	G2	N/A	N/A
Pearl	W2	W2	W2	CA
Peppercorn	C14	C14	N/A	N/A
Regatta Blue	L2	L2	L2	N/A
Rye	D21	D21	D21	BS
Saddle	D6	D6	D6	ST
Slate	L10	L10	L10	N/A
Spruce	G17	G17	G17	N/A
Wheat	Y1	Y1	Y1	N/A
Wicker	D8	D8	D8	WI

<b>VARIFORM</b>	Smooth ATCS24 --	Woodgrain ATCW24T --	PVC ATCP24 --	Rainware Comparable
Autumn Beige	D31	D31	N/A	N/A
Briarwood	B9	B9	N/A	N/A
Classic Cream	D22	D22	D22	CC
Delray Sand	Y1	Y1	Y1	N/A
Flint	A7	A7	N/A	N/A
Georgian Gray	A4	A4	A4	N/A
Irish Thistle	A1	A1	A1	N/A
Island Pearl	W2	W2	W2	CA
Mediterranean Palm	G2	G2	N/A	N/A
Natural Almond	D13	D13	D13	N/A
Santone	D6	D6	D6	ST
Sandy Tan	D33	D33	D33	N/A
Silver Mist	D37	D37	D37	N/A
Stone Mountain Clay	D47	D47	D47	SI
Wedgewood	A11	A11	N/A	N/A

<b>ROYAL</b>	Smooth ATCS24 --	Woodgrain ATCW24 --	PVC ATCP24 --	Rainware Comparable
Beige	D10	D10	D10	N/A
Brownstone	D26	D26	N/A	NW
Clay	D21	D21	D21	BS
Cypress	G1	G1	G1	N/A
Driftwood	D37	D37	N/A	N/A
Flagstone	A1	A1	A1	N/A
Granite	A25	A25	A25	GG
Harvard Slate	A2	A2	A2	HG
Heather	G8	G8	G8	N/A
Ironstone	C7	C7	N/A	N/A
Linen	W10	W10	W10	LN
Marine Blue	C12	C12	N/A	N/A
Midnight Surf	L10	L10	L10	N/A
Natural Cedar	D65	D65	D65	N/A
Pebble Clay	D5	D5	D5	PC
Redwood	R6	R6	R6	N/A
Rockslide	A9	A9	N/A	N/A
Sand	D7	D7	D7	N/A
Shamrock	G17	G17	G17	N/A
Soft Maple	D12	D12	D12	N/A
Sterling	A3	A3	A3	SG
Storm	A22	A22	A22	N/A
Tree Moss	G12	G12	G12	N/A
Urban Bronze	C14	C14	N/A	N/A
Vintage Cream	D30	D30	D30	N/A
Wicker	D8	D8	D8	WI
Walnut	B9	B9	N/A	N/A

<b>JAMES HARDIE</b>	Smooth ATCS24 --	Woodgrain ATCW24T --	PVC ATCP24 --
Aged Pewter / Deep Ocean	C12	C12	N/A
Arctic White / Woodstock Brown	C2	C2	N/A
Chestnut Brown / Evening Blue	C8	C8	N/A
Cobblestone / Autumn Tan	C6	C6	N/A
Heathered Moss / Boothbay Blue	C9	C9	N/A
Iron Gray / Countryside Red	C7	C7	N/A
Khaki Brown / Sail Cloth	C1	C1	N/A
Monterey Taupe / Sandstone Beige	C11	C11	N/A
Mountain Sage / Light Mist	C10	C10	N/A
Navajo Beige / Timber Bark	C5	C5	N/A
Night Gray / Pearl Gray	C13	C13	N/A
Rich Espresso / Gray Slate	C14	C14	N/A
Sandstone Beige	N/A	N/A	D15

<b>PELLA® Window</b>	Smooth ATCS24 --	Woodgrain ATCW24T --	PVC ATCP24 --
Almond	D62	D62	N/A
Black	A27	A27	A27
Brick Red	R7	R7	N/A
Brown	B22	B22	N/A
Hartford Green	G20	G20	G18
Morning Sky	A28	A28	A28
Poplar White	D61	D61	N/A
Portobello	B23	B23	N/A
Putty	D63	D63	N/A
Tan	D64	D64	N/A
White	C2	C2	N/A

# Trim Coil Offering

APOLLO BEACH PLANT

<b>Trim Coil</b>	<b>Description (Nominal Thickness)</b>	<b>Piece Length</b>	<b>Pieces/ Box</b>	<b>Boxes/ Pallet</b>	<b>Pieces/ Pallet</b>	<b>Rolls/ Truck</b>
	.019 Aluminum Trim Coil	50'	1	48	48	1248

*Unless otherwise stated, all Smooth and Wood Grain trim coil is white (W1) on the opposite side.*

<b>ALLURA COLORMAX</b>	<b>Smooth ATCS24 --</b>	<b>Woodgrain ATCW24T --</b>	<b>PVC ATCP24 --</b>	<b>Rainware Comparable</b>
Ashen	C6	C6	N/A	N/A
Autumn Red	R6	R6	R6	N/A
Bark	C14	C14	C14	N/A
Cool Charcoal	C12	C12	N/A	N/A
Desert Tan	D13	D13	D13	N/A
Flagstone	A22	A22	A22	N/A
Granite Gray	A13	A13	A13	N/A
Linen	D7	D7	D7	N/A
Natural Clay	D26	D26	N/A	N/A
Pacific Blue	L8	L8	L8	N/A
Rock Cliffs	C6	C6	N/A	N/A
Sable Brown	B20	B20	B20	N/A
Savannah Wicker	D8	D8	D8	N/A
Snow	W1	W1	W1	WH
Sterling Gray	A28	A28	A28	N/A
Taupe	D47	D47	D47	SI

PROUDLY FINISHED WITH  
**SHERWIN-WILLIAMS**  
 Coil Coatings



# NORANDEX Fascia

## APOLLO BEACH PLANT

Fascia	Part #	Description	Colors	Nominal Thickness	Piece Length	Pieces/Box	Boxes/Pallet	Pieces/Pallet
--------	--------	-------------	--------	-------------------	--------------	------------	--------------	---------------

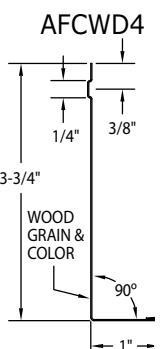
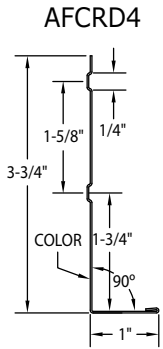

### 4" Fascia

AFCRC4	--	Alum. 4" Commercial Ribbed Fascia	AI, AL, BK, CG, MB, RB, WH	0.019	12'	25	42	1050
AFCRD4	--	Alum. 4" Deluxe Ribbed Fascia	WH	0.024	12'	25	42	1050
AFCSD4	--	Alum. 4" Deluxe No Rib Fascia	WH	0.024	12'	25	42	1050
AFCWC4	--	Alum. 4" Commercial Wood Grain Fascia	AI, AL, BK, RB, CG, MB, WH	0.019	12'	25	42	1050
AFCWD4	--	Alum. 4" Deluxe Wood Grain Fascia	WH	0.024	12'	25	42	1050

### 6" Fascia

AFCR6	--	Alum. 6" Ribbed Fascia (Beloit)	BK, WH	0.024	12'	25	24	600
AFCRC6	--	Alum. 6" Commercial Ribbed Fascia	AI, AL, BZ, BK, CG, MB, RB, WH	0.019	12'	25	37	925
AFCRD6	--	Alum. 6" Deluxe Ribbed Fascia	WH	0.024	12'	25	37	925
AFCSC6	--	Alum. 6" Commercial Smooth Fascia	AI, AL, BK, BZ, MB, RB, WH	0.019	12'	25	37	925
AFCSD6	--	Alum. 6" Deluxe Smooth Fascia	WH	0.024	12'	25	37	925
AFCWC6	--	Alum. 6" Comm. Wood Grain Fascia	AI, AL, BK, BZ, RB, CG, MB, WH	0.019	12'	25	37	925
AFCWD6	--	Alum. 6" Deluxe Wood Grain Fascia	WH	0.024	12'	25	37	925

### 8" Fascia

AFCR8	--	Alum. 8" Ribbed Fascia (Beloit)	BK, WH	0.024	12'	25	20	500
AFCSC8	--	Alum. 8" Commercial Smooth Fascia	WH	0.019	12'	25	20	600
AFCRD8	--	Alum. 8" Deluxe Ribbed Fascia	WH	0.024	12'	25	24	600
AFCWC8	--	Alum. 8" Comm. Wood Grain Fascia	BZ, RB, MB, WH	0.019	12'	25	24	600
AFCWD8	--	Alum. 8" Deluxe Wood Grain Fascia	WH	0.024	12'	25	24	600
AFCWRC8	--	Alum. 8" Comm. Wood Grain Ribbed Fascia	MB, WH	0.019	12'	25	24	600

♦TCG - TAMPA CHARCOAL GREY - "U" Use up until gone

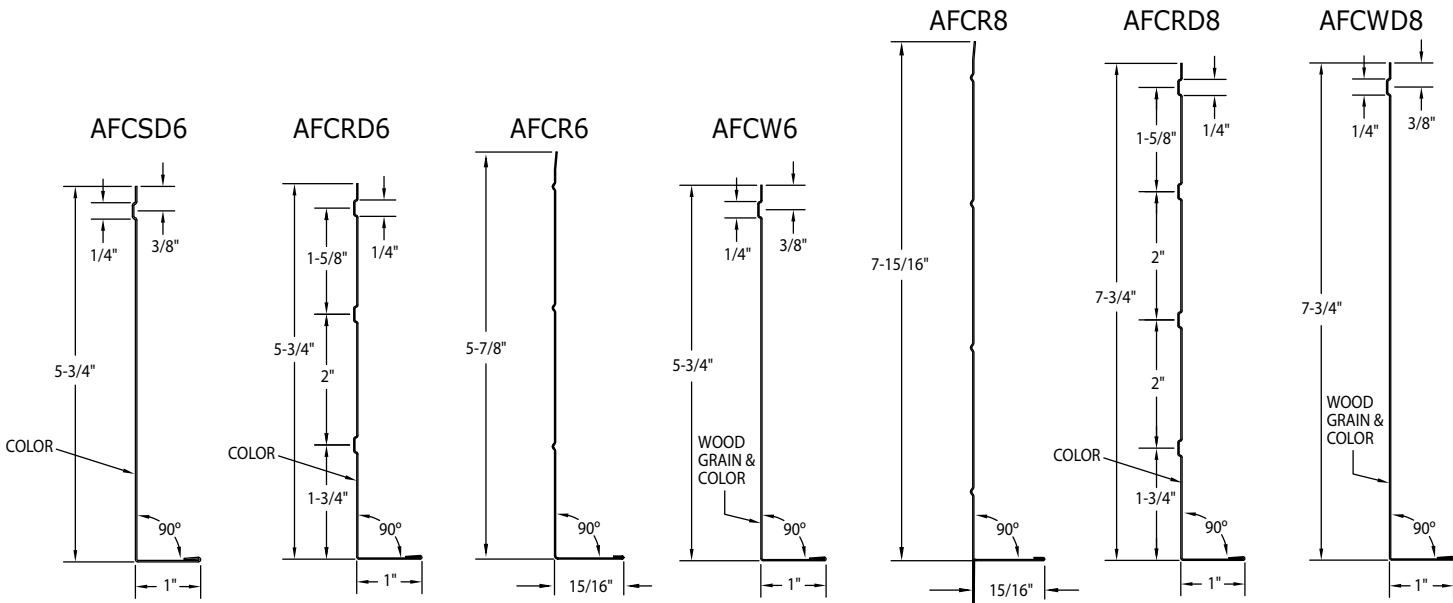

### Fascia Colors:

COLOR	CODE	COLOR	CODE	COLOR	CODE	COLOR	CODE	COLOR	CODE
NX ALMOND	D49	BLACK	BK	NX LINEN	W10	MUSKET BROWN	MB	ROYAL BROWN	RB
ALMOND	AL	BRONZE	BZ	WHITE	WH	NX SAND STONE	D46		
ANTIQUÉ IVORY	AI	CHARCOAL GREY	CG			NX SIERRA CLAY	D47		



# NORANDEX™ Soffit

APOLLO BEACH PLANT

## 12" Double 6 - D6 Soffit

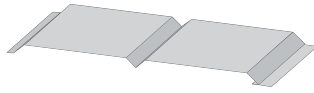

Part #	Description	Colors	Nominal Thickness	Piece Length	Pieces/Box	Boxes/Pallet	Pieces/Pallet
ASTD6S - -	Aluminum Solid D6 Soffit	WH	0.019	12'	16	24	384
ASTD6V - -	Aluminum Full Vent D6 Soffit	WH	0.019	12'	16	24	384

**NOTE:** Requires 1/2" accessory channels.  
Does not have Miami Dade approval.

**D6 Soffit NFA 10.37 sq. in. / sq. ft.**

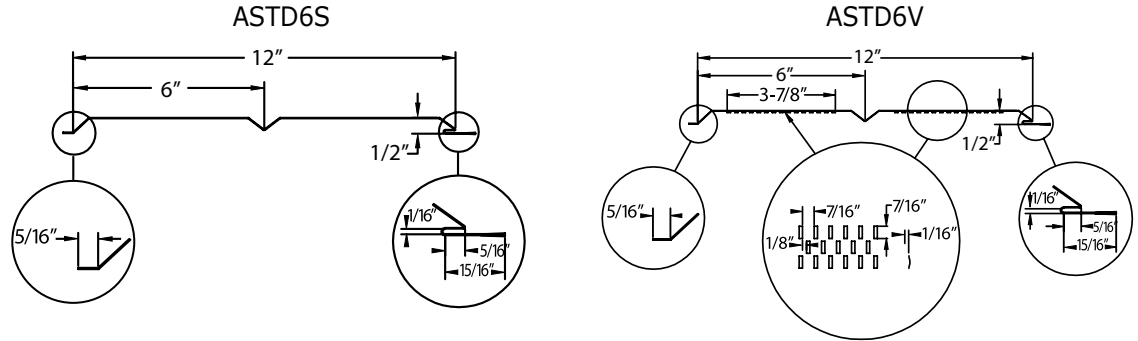

## 12" U-Style Soffit (also known as Triple 4)

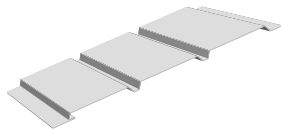

Part #	Description	Colors	Nominal Thickness	Piece Length	Pieces/Box	Boxes/Pallet	Pieces/Pallet
*AST12S - -	Aluminum 12" Solid Soffit	(Listed Below)	0.019	12'	20	15	300
*AST12CV - -	Aluminum 12" Center Vent Soffit	(Listed Below)	0.019	12'	20	15	300
*AST12FV - -	Aluminum 12" Full Vent Soffit	(Listed Below)	0.019	12'	20	15	300

**NOTE:** Requires 3/8" accessory channels.

\*Complies with Florida Product Approval, # FL12019-R9

\*\* ILL-ES AC 132 Calculation (Refer to website for NFA details [acm-metals.com/Resources/Specification Sheets/Soffit NFA Data](http://acm-metals.com/Resources/Specification%20Sheets/Soffit%20NFA%20Data))

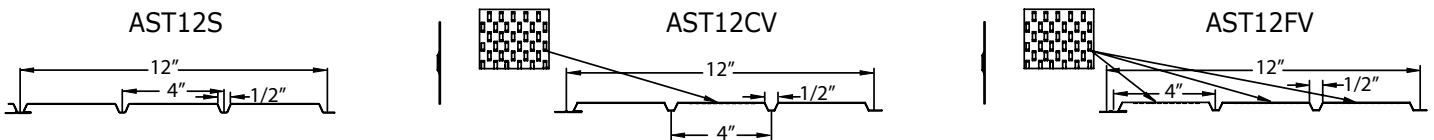

### U-Style Soffit Colors:

COLOR	CODE	COLOR	CODE	COLOR	CODE	COLOR	CODE	COLOR	CODE
NX ALMOND	D49	BLACK	BK	NX LINEN	W10	ROYAL BROWN	RB	NX SIERRA CLAY	D47
ALMOND	AL	BRONZE	BZ	PEBBLESTONE CLAY	PC	NX SAND STONE	D46	WHITE	WH



# NORANDEX™ Soffit

APOLLO BEACH PLANT

## 12" V-Style Soffit (also known as Triple 4)

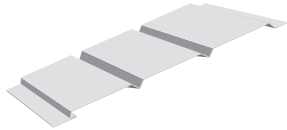

### 12" V-Style Soffit

Part #	Description	Colors	Nominal Thickness	Piece Length	Pieces/Box	Boxes/Pallet	Pieces/Pallet
*ASTN12S	Alum. 12" T/4 NASA Solid Soffit (Listed Below)		0.012	12'	20	27	540
*ASTN12C	Alum. 12" T/4 NASA Center Vent Soffit (Listed Below)		0.012	12'	20	27	540
*ASTN12F	Alum. 12" T/4 NASA Full Vent Soffit (Listed Below)		0.012	12'	20	27	540

\*Complies with Florida Product Approval, # FL12019-R9

\*\* ILL-ES AC 132 Calculation (Refer to website for NFA details [acm-metals.com/Resources/Specification Sheets/Soffit NFA Data](http://acm-metals.com/Resources/Specification%20Sheets/Soffit%20NFA%20Data))

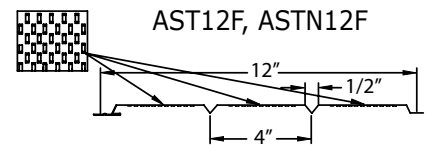
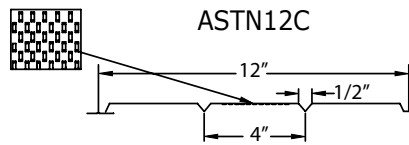
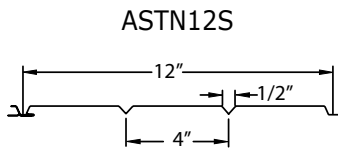

## 16" V-Style Soffit (also known as Quad 4)

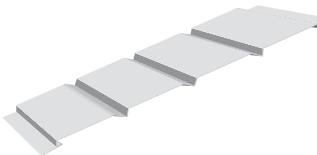

### 16" V-Style Soffit

Part #	Description	Colors	Nominal Thickness	Piece Length	Pieces/Box	Boxes/Pallet	Pieces/Pallet
*ASTN16S	Alum. 16" Q/4 NASA Solid Soffit (Listed Below)		0.012	12'	20	20	400
*ASTN16F	Alum. 16" Q/4 NASA Full Vent Soffit (Listed Below)		0.012	12'	20	20	400

\*Complies with Florida Product Approval, # FL12019-R9

\*\* ILL-ES AC 132 Calculation (Refer to website for NFA details [acm-metals.com/Resources/Specification Sheets/Soffit NFA Data](http://acm-metals.com/Resources/Specification%20Sheets/Soffit%20NFA%20Data))

**NOTE:** Requires 3/8" accessory channels.

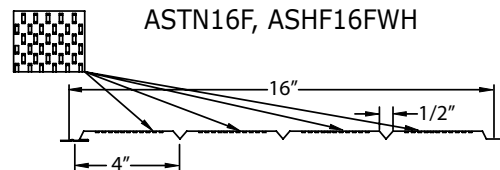
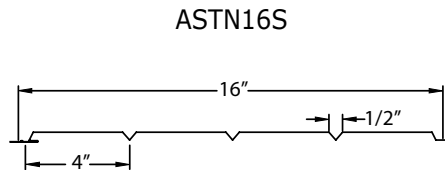

### 12" & 16" V-Style Soffit Colors:

COLOR	CODE	COLOR	CODE	COLOR	CODE
ALMOND	AL	CHARCOAL GREY	CG	WHITE	WH
ANTIQUÉ IVORY	AI	MUSKET BROWN	MB	ROYAL BROWN	RB
BRONZE	BZ			BLACK	BK



# NORANDEX™ Siding Accessories

APOLLO BEACH PLANT

## F-Channel

Part #	Description	Colors	Nominal Thickness	Piece Length	Pieces/ Box	Boxes/ Pallet	Pieces/ Pallet
AUF38	Alum. 3/8" Universal F-Channel	AI, AL, BK, BZ, CG, MB, RB, WH	0.019	12'	25	24	600
AF12	Alum. 1/2" F-Channel	BK, WH	0.019	12'	25	24	600

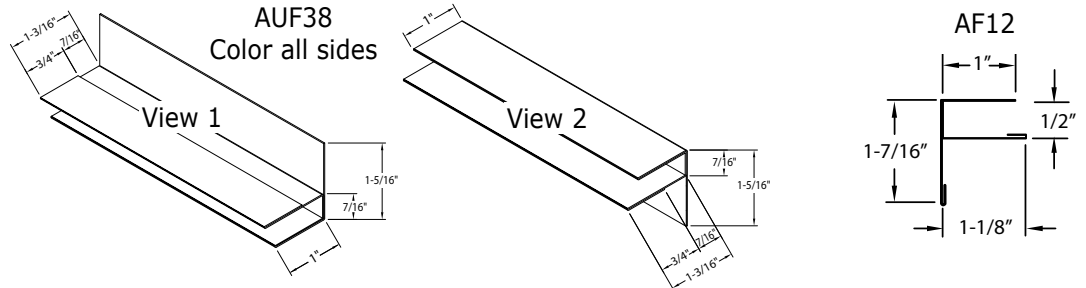

## J-Channel

Part #	Description	Colors	Nominal Thickness	Piece Length	Pieces/ Box	Boxes/ Pallet	Pieces/ Pallet
AWJ38	Alum. 3/8" J-Channel (Wide Face)	AI, AL, BK, BZ, CG, MB, RB, WH	0.019	12'	50	12	600
AJ12T	Aluminum 1/2" J-Channel	WH	0.019	12'	50	12	600

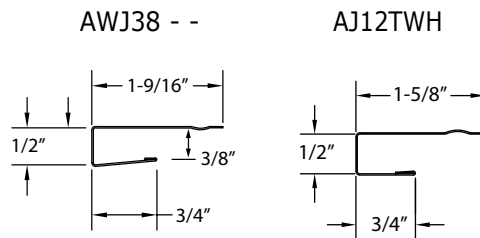
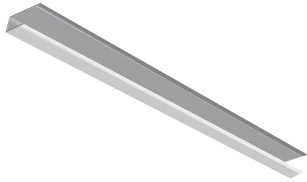

### Colors:

COLOR	CODE	COLOR	CODE	COLOR	CODE
ALMOND	AL	BRONZE	BZ	ROYAL BROWN	RB
ANTIQUÉ IVORY	AI	CHARCOAL GREY	CG	WHITE	WH
BLACK	BK	MUSKET BROWN	MB		

## Starter Strip

Part #	Description	Colors	Nominal Thickness	Piece Length	Pieces/ Box	Boxes/ Pallet	Pieces/ Pallet
ASS25ML	Aluminum 2-1/2" Starter Strip	Mill	0.019	10'	50	24	1200
ASS35ML	Aluminum 3-1/2" Starter Strip	Mill	0.019	10'	25	24	600
GSS25ML	Galvanized 2-1/2" Starter Strip	Mill	28 ga	10'	50	24	1200
GSS35ML	Galvanized 3-1/2" Starter Strip	Mill	28 ga	10'	25	24	600

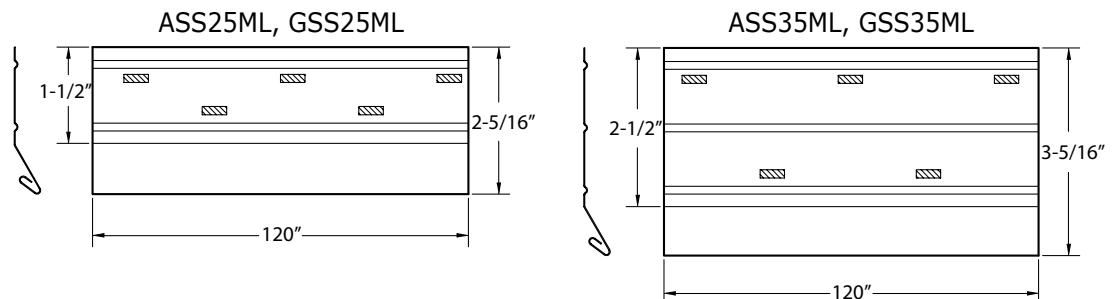
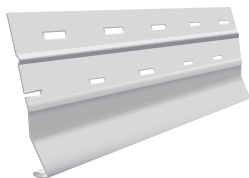





# NORANDEX™ Siding Accessories

APOLLO BEACH PLANT

## Z Flashing

Part #	Description	Colors	Nominal Thickness	Piece Length	Pieces/Box
AZF38WH	Aluminum 3/8" Z Flashing	WH	0.019	10'	25



Part No.	"A"	"B"
AZF38	3/8"	2-1/4"

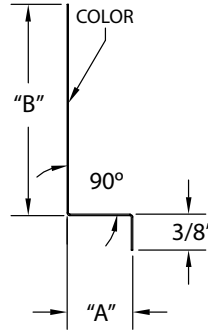

## Drip Cap

Part #	Description	Colors	Nominal Thickness	Piece Length	Pieces/Box
--------	-------------	--------	-------------------	--------------	------------

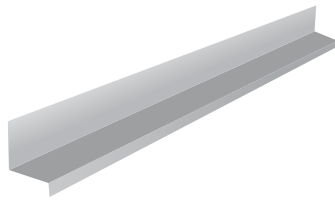

### 90° Drip Cap

ADC078WH	Aluminum 7/8" Drip Cap 90°	WH	0.019	10'	25
ADC100WH	Aluminum 1" Drip Cap 90°	WH	0.019	10'	25
ADC150 - -	Aluminum 1-1/2" Drip Cap 90°	RB, WH	0.019	10'	25

### 95° Drip Cap

ADC95150WH	Aluminum 1-1/2" Drip Cap 95°	WH	0.019	10'	25
------------	------------------------------	----	-------	-----	----

#### Drip Cap 90°

Part No.	"A"	"B"
ADC078	7/8"	1-5/8"
ADC100	1"	1-9/16"
ADC150	1-1/2"	1-1/16"

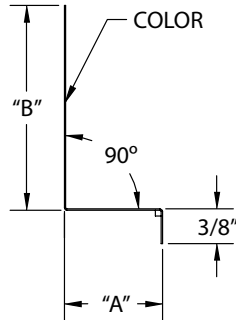

#### Drip Cap 95°

Part No.	"A"	"B"
ADC150	1-1/2"	1-1/16"

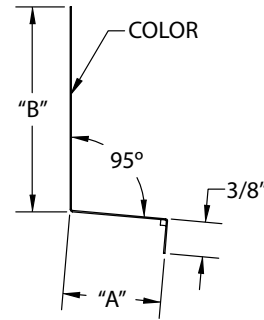

## ALUMINUM Fascia & Soffit Accessories Colors:

COLOR	CODE	COLOR	CODE
ROYAL BROWN	RB	WHITE	WH



## ALUMINUM LIMITED LIFETIME WARRANTY GUTTER SYSTEM PRODUCTS

Norandex manufactures Aluminum Gutter Coil and Gutter System Products in accordance with high standards and tight quality controls. The aluminum products will not rust, burn, support combustion, split, or crack due to cold weather.



### BUY NORANDEX GUTTER SYSTEM PRODUCTS WITH CONFIDENCE KNOWING THAT:

- Norandex Aluminum Gutter System products carry a Limited Lifetime Warranty.
- Material and Labor is covered.
- Transferable at no charge.
- Doesn't require registration.

### WHAT DOES THIS WARRANTY COVER?

Norandex warrants to the owner of the property at the time the products were installed, that the products are free from defects in material and workmanship in the course of manufacture, and that the finish on the products will not chip, peel, flake, or blister under conditions of ordinary wear if installed according to local building codes and industry specifications. This warranty is limited to the terms and conditions, exclusions and limitations, requirements and legal rights stated in this warranty.

### HOW LONG DOES THE COVERAGE LAST?

If the property is individually owned, this Limited Lifetime Warranty lasts for the life of the property on which the products were originally applied for as long as the individual owns the property. If the property is not individually owned (e.g., corporation, condominium, cooperative housing arrangement, unincorporated association, school, church, government or public entity, etc.), the warranty period will be 50-years from the date of original installation of the products on the property, prorated as outlined in the Warranty Coverage Schedule contained within. This Limited Lifetime Warranty may be transferred with the property. However, upon the transfer, the warranty period will be no more than 50-years from the date of original installation of the products on the property, prorated in accordance with the Warranty Coverage Schedule contained within.

### WHAT WILL NORANDEX DO?

Property owner must notify Norandex in accordance with the notice requirements outlined below to validate the complaint. In the event Norandex is denied access for an inspection, this warranty is null and void. Upon the notification and validation, Norandex will undertake the following: Norandex will repair, replace, or refund the purchase price of the defective portion of Norandex product that blisters, cracks, crazes, flakes, peels, or weathers unevenly due to a defect in the manufacturing process. Norandex obligations under this warranty will in no event exceed the purchase price of the originally installed products found to be warrantable and the cost of the labor involved in the original installation of such defective products. Any additional costs and expenses beyond these amounts are the property owner's responsibility. Norandex will not pay or be responsible for any costs associated with anything else affixed to the Norandex Metals product.

In the event of repair, replacement, or refinishing, the warranty will extend only for the time remaining under the original warranty. Norandex will determine the reasonable labor costs to repair, repaint, or replace product under this warranty.

### WHAT IS NOT COVERED UNDER THE WARRANTY?

This warranty does not cover damage of any kind resulting from:

- Uninstalled product that is stored in situations where standing water is covering the surface for a prolonged period of times.
- Buckling or rippling of gutters.

- Faulty or improper contractor fabrication or installation, including "oil canning", waving, buckling, or other distortions.
- Installation of product in direct contact with dissimilar materials or salt spray.
- Cracking or crazing of the paint surface due to field forming of products in cold temperatures.
- Changes in surface color resulting from chalking, fading, soiling, tree sap, or staining. Exposure to the elements may cause these changes over time; the degree to which weathering occurs will vary depending on air quality, the building's location, and other local conditions over which Norandex has no control.
- Accidental damage.
- Settlement.
- Structural shrinkage or distortion of the property structure.
- Fire.
- Lightning, hurricane, tornado, windstorm, earthquake, hail, ice damage or other acts of God.
- Harmful chemicals including harmful cleaning compounds, herbicides, fertilizers, and pesticides.
- Fumes, volcanic smog, or vapors within 30-miles of volcano.
- Surface deterioration due to air pollution, use for animal confinement structures, or within a mile of seacoast and other bodies of saltwater.
- Misuse or abuse. Use of high pressure sprayers will void warranty.
- Vandalism;
- Airborne stains, mold and mildew accumulation.
- Tiger striping or atmospheric soil accumulation is a naturally occurring phenomenon that is not covered under the finish warranty.
- Failure of original or subsequent property owners to provide reasonable and necessary maintenance of the products (see "Care & Maintenance Instructions").
- Impact of foreign objects.
- Warping or distortion due to exposure to excessive heat sources (e.g., barbecue grills), or exposure to unusual or excessive reflective heat sources (e.g., window reflection).
- Products that have been painted, reinstalled, or whose surface has been altered in any way will void the paint finish warranty.
- Any other causes beyond Norandex reasonable control.

### OTHER LIMITATIONS

1. This warranty covers only genuine Norandex Aluminum Gutter Coil and Gutter System products. It is the responsibility of the property owner to verify that the Gutter System products installed are Norandex products. Norandex products are warranted in the continental United States, Hawaii, and Alaska.
2. Gutter Coil is designed and intended for Gutter System applications and should not be used as roofing material or metal dome gutter protection due to esthetic reasons.
3. Due to normal weathering, replacement products may differ in gloss and color from products originally installed on the property.
4. Norandex reserve the right to discontinue or change any design or color of any products, at any time, and without notice or liability. If products of the type originally installed are no longer available, Norandex may substitute another product determined to be of comparable quality and price.

Continued on next page →

### ACM Customer Service

MW / NE - 877-279-5096

SE - 800-749-4067

SW - 800-357-7523

W - 877-213-5962



## ALUMINUM LIMITED LIFETIME WARRANTY

# SIDING ACCESSORIES

Norandex manufactures Aluminum Siding Accessories which include Trim Coil, Soffit, Fascia, Soffit Channels, Drip Cap, and Z-Flashings, in accordance with high standards and tight quality controls. The aluminum products will not rust, burn, support combustion, split, or crack due to cold weather.



### BUY NORANDEX ALUMINUM SIDING ACCESSORIES WITH CONFIDENCE KNOWING THAT:

- Norandex aluminum siding accessories carry a Limited Lifetime Warranty.
- Material and Labor is covered.
- Transferable at no charge.
- Doesn't require registration.

### WHAT DOES THIS WARRANTY COVER?

Norandex warrants to the owner of the property at the time the products were installed, that the products are free from defects in material and workmanship in the course of manufacture, and that the finish on the products will not chip, peel, flake, or blister under conditions of ordinary wear if installed according to local building codes and industry specifications. This warranty is limited to the terms and conditions, exclusions and limitations, requirements, and legal rights stated in this warranty.

### HOW LONG DOES THE COVERAGE LAST?

If the property is individually owned, this Limited Lifetime Warranty lasts for the life of the property on which the products were originally applied for as long as the individual owns the property. If the property is not individually owned (e.g., corporation, condominium, cooperative housing arrangement, unincorporated association, school, church, government or public entity, etc.), the warranty period will be 50-years from the date of original installation of the products on the property, prorated as outlined in the Warranty Coverage Schedule contained within. This Limited Lifetime Warranty may be transferred with the property. However, upon the transfer, the warranty period will be no more than 50-years from the date of original installation of the products on the property, prorated in accordance with the Warranty Coverage Schedule contained within.

### WHAT WILL NORANDEX DO?

Property owner must notify Norandex in accordance with the notice requirements outlined below to validate the complaint. In the event Norandex is denied access for an inspection, this warranty is null and void. Upon the notification and validation, Norandex will undertake the following: Norandex will repair, replace, or refund the purchase price of the defective portion of Norandex product that blisters, cracks, crazes, flakes, peels, or weathers unevenly due to a defect in the manufacturing process. Norandex obligations under this warranty will in no event exceed the purchase price of the originally installed products found to be warrantable and the cost of the labor involved in the original installation of such defective products. Any additional costs and expenses beyond these amounts are the property owner's responsibility. Norandex will not pay or be responsible for any costs associated with anything else affixed to the Norandex product.

In the event of repair, replacement, or refinishing, the warranty will extend only for the time remaining under the original warranty. Norandex will determine the reasonable labor costs to repair, repaint, or replace product under this warranty.

### WHAT IS NOT COVERED UNDER THE WARRANTY?

This warranty does not cover damage of any kind resulting from:

- Uninstalled product that is stored in situations where standing water is covering the surface for a prolonged period of times.

- Faulty or improper contractor fabrication or installation, including waving, buckling, or other distortions.
- Installation of product in direct contact with dissimilar materials or salt spray.
- Cracking or crazing of the paint surface due to field forming of products in cold temperatures.
- Changes in surface color resulting from chalking, fading, soiling, tree sap, or staining. Exposure to the elements may cause these changes over time; the degree to which weathering occurs will vary depending on air quality, the building's location, and other local conditions over which Norandex has no control.
- Accidental damage.
- Settlement.
- Structural shrinkage or distortion of the property structure.
- Fire.
- Lightning, hurricane, tornado, windstorm, earthquake, hail, ice damage or other acts of God.
- Harmful chemicals including harmful cleaning compounds, herbicides, fertilizers, and pesticides.
- Fumes, volcanic smog, or vapors within 30-miles of volcano.
- Surface deterioration due to air pollution, use for animal confinement structures, or within a mile of seacoast and other bodies of saltwater.
- Misuse or abuse. Use of high pressure sprayers will void warranty.
- Vandalism.
- Airborne stains, mold and mildew accumulation.
- Tiger striping or atmospheric soil accumulation is a naturally occurring phenomenon that is not covered under the finish warranty.
- Failure of original or subsequent property owners to provide reasonable and necessary maintenance of the products (see "Care & Maintenance Instructions").
- Impact of foreign objects.
- Warping or distortion due to exposure to excessive heat sources (e.g., barbecue grills), or exposure to unusual or excessive reflective heat sources (e.g., window reflection).
- Products that have been painted, reinstalled, or whose surface has been altered in any way will void the paint finish warranty.
- Any other causes beyond Norandex reasonable control.

### OTHER LIMITATIONS

1. This warranty covers only genuine Norandex aluminum siding accessories. It is the responsibility of the property owner to verify that the siding accessories installed are Norandex products. Norandex products are warranted in the continental United States, Hawaii, and Alaska.
2. Oil canning is a natural occurring phenomenon on the surface of soffit panels and is associated with the milling of thinner gauge Aluminum. Norandex guarantees these spans with specific thickness to be free of oil canning:
  - .012 2-Foot Spans
  - .019 6-Foot Spans
3. Due to normal weathering, replacement products may differ in gloss and color from products originally installed on the property.
4. Norandex reserve the right to discontinue or change any design or color of any products, at any time, and without notice or liability. If products of the type originally installed are no longer available, Norandex may substitute another product determined to be of comparable quality and price.

Continued on next page →

### ACM Customer Service

MW / NE - 877-279-5096

SE - 800-749-4067

SW - 800-357-7523

W - 877-213-5962



## STEEL LIMITED LIFETIME WARRANTY GUTTER SYSTEM PRODUCTS

Norandex manufactures Steel Gutter System Products including gutter coil in accordance with high standards and tight quality controls. The products will not burn, support combustion, or split, or crack due to cold weather because they are made of steel.



### BUY NORANDEX STEEL GUTTER SYSTEM PRODUCTS WITH CONFIDENCE KNOWING THAT:

- Norandex Steel Gutter System products carry a Limited Lifetime Warranty.
- Material and Labor is covered.
- Doesn't require registration.

### WHAT DOES THIS WARRANTY COVER?

Norandex warrants to the owner of the property at the time the products were installed, that the products are free from defects in material and workmanship in the course of manufacture, and that the finish on the products will not chip, peel, flake, or blister under conditions of ordinary wear if installed according to local building codes and industry specifications. This warranty excludes any areas of the material that are within 3/4" of any edge that has been cut subsequent to the application of the paint to the substrate. This warranty is limited to the terms and conditions, exclusions and limitations, requirements, and legal rights stated in this warranty.

### HOW LONG DOES THE COVERAGE LAST?

If the property is individually owned, this Limited Lifetime Warranty lasts for the life of the property on which the products were originally applied for as long as the individual owns the property. If not individually owned (e.g., corporation, condominium, cooperative housing arrangement, unincorporated association, school, church, government or public entity, etc.), the warranty period will be 50-years from the date of original installation of the products on the property, prorated as outlined in the Warranty Coverage Schedule contained within. This Limited Lifetime Warranty is limited to the original owner. Coverage will be 100% for 10-years after the installation and prorated after that period. See Warranty Coverage Schedule section for details of prorated coverage.

### WHAT WILL NORANDEX DO?

Property owner must notify Norandex in accordance with the notice requirements outlined below to validate the complaint. In the event the manufacturer is denied access for an inspection, this warranty is null and void. Upon the notification and validation, Norandex will undertake the following: Norandex will repair, replace, or refund the purchase price of the defective portion of the product that blisters, cracks, crazes, flakes, peels, or weathers unevenly due to a defect in the manufacturing process. Norandex obligations under this warranty will in no event exceed the purchase price of the originally installed products found to be warrantable and the cost of the labor involved in the original installation of such defective products. Any additional costs and expenses beyond these amounts are the property owner's responsibility. Norandex will not pay or be responsible for any costs associated with anything else affixed to the Norandex product.

In the event of repair, replacement, or refinishing, the warranty will extend only for the time remaining under the original warranty. Norandex will determine the reasonable labor costs to repair, repaint, or replace product under this warranty.

### WHAT IS NOT COVERED UNDER THE WARRANTY?

This warranty does not cover damage of any kind resulting from:

- Product that is stored in situations where standing water is covering the surface for prolonged period of time.
- Faulty or improper installation, including "oil canning", waving, buckling, or other distortions.
- Installation of Norandex product in direct contact with dissimilar materials, salt spray, and cedar shake roofing.
- Cracking or crazing of the Product's paint surface due to field forming of products in cold temperatures; or material that has bends less than 2T for a sheet thickness of 0.0299" and thinner and bends less than 4T for a sheet thickness of 0.0300" and thicker.
- Changes in surface color resulting from chalking, fading, soiling, tree sap, or staining. Exposure to the elements may cause these changes over time; the degree to which weathering occurs will vary depending on air quality, the building's location, and other local conditions over which Norandex has no control.
- Accidental damage.
- Settlement.
- Structural shrinkage or distortion of the property structure.
- Fire.
- Lightning, hurricane, tornado, windstorm, earthquake, hail, ice damage or other acts of God.
- Harmful chemicals including harmful cleaning compounds, herbicides, fertilizers, and pesticides.
- Fumes, volcanic smog, or vapors within 30-miles of volcano.
- Surface deterioration due to air pollution, use for animal confinement structures, or within 1-mile of seacoast and other bodies of saltwater.
- Misuse or abuse. Use of high pressure sprayers will void warranty.
- Vandalism.
- Airborne stains, mold and mildew accumulation.
- Tiger striping or atmospheric soil accumulation is a naturally occurring phenomenon that is not covered under the finish warranty.
- Failure of original property owner to provide reasonable and necessary maintenance of the products (see "Care & Maintenance Instructions").
- Impact of foreign objects.
- Warping or distortion due to exposure to excessive heat sources (e.g., barbecue grills) or exposure to unusual or excessive reflective heat sources (e.g., window reflection).
- Products that have been painted, reinstalled, or whose surface has been altered in any way will void the paint finish warranty.
- Any other causes beyond Norandex reasonable control.

Continued on next page →

### ACM Customer Service

MW / NE - 877-279-5096

SE - 800-749-4067

SW - 800-357-7523

W - 877-213-5962

(Complete Steel Warranty available upon request)







**NORANDEX™**

**NOTES:**

---

---

---

---

---

---

---

---

---

---

---

---

---

---

---

---

---

---

---

---

---

---

---

---

---

---

---

---



**NORANDEX™**

EXTERIOR PRODUCTS FOR YOUR HOME

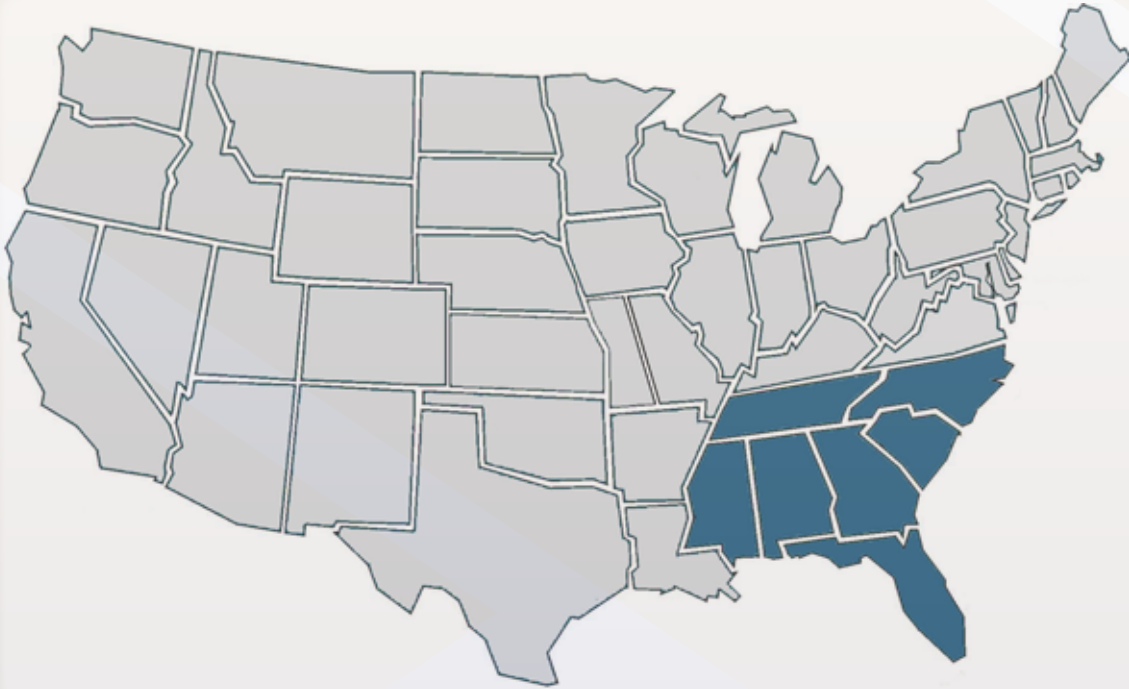

*Serving the Southeast Region*