



# NORANDEX™

EXTERIOR PRODUCTS FOR YOUR HOME

*See NEW Premium  
Stainless Steel Micro  
Mesh Gutter Screen  
Pg 24*

**RAINWARE, TRIM COIL  
& SIDING ACCESSORIES**

**Beloit Plant**

**[www.acm-metals.com](http://www.acm-metals.com)**

**Table of Contents**

<b>Norandex™ Rainware Components &amp; Accessories</b> .....	<b>1</b>	Half Round Slip Joints .....	24
<b>Norandex™ Rainware Color Selection Chart</b> .....	<b>2-3</b>	Half Round End Caps .....	24
<b>Gutter Coil Conversion Chart</b> .....	<b>4</b>	Half Round Brackets .....	25
<b>Gutters</b> .....	<b>5-6</b>	Half Round Hidden Hangers .....	25
Gutter Coil .....	5	Half Round T-Wedge Hangers.....	25
Spin Down Gutter Coil .....	6	<b>Gutter Protection.....</b>	<b>26-28</b>
<b>Downspouts</b> .....	<b>7</b>	Gutter Protection Screen Systems .....	26
<b>Elbows.....</b>	<b>8-9</b>	Gutter Protection Perforated .....	27
<b>Variable Degree Elbows.....</b>	<b>10</b>	& Cover Systems	
<b>Offsets</b> .....	<b>11-12</b>	Gutter Protection & Accessories.....	28
<b>Conductor Heads</b> .....	<b>12</b>	<b>Norandex™ Trim Coil Color Selection Chart</b> .....	<b>30-31</b>
<b>Downspout Accessories.....</b>	<b>13-14</b>	<b>Trim Coil Offering</b> .....	<b>32-24</b>
Outlets .....	13	Norandex™ .....	32
Wire Strainers .....	13	Mastic Comparable .....	32
Drain Tile Adapters.....	13	Textured, Mar-Resistant Window Trim Coil .....	32
Y Adapters .....	13	Specialty Coils .....	32
Y Diverters.....	13	Certainteed Comparable.....	33
Funnels .....	14	Exterior Portfolio Comparable .....	33
Downspout Bands .....	14	Variform Comparable.....	33
Downspout Clips .....	14	Royal Comparable .....	33
Downspout Cleats .....	14	James Hardie Comparable .....	33
Downspout Hinges .....	14	Allura™ ColorMax® Comparable .....	34
Splash Blocks .....	14	LP® Siding SmartSide® Comparable .....	34
<b>Miters.....</b>	<b>15</b>	Everlast® by Norandex™ .....	34
Extreme™ Miters .....	15	Extreme Windows by Norandex™ .....	34
Box Miters.....	15	Perfexion by Norandex™ .....	34
Bay Miters.....	15	Pella® Window Comparable.....	34
<b>Strip Miters &amp; Joints.....</b>	<b>16</b>	Andersen® Windows Comparable.....	34
Strip Miters .....	16	<b>Fascia.....</b>	<b>35-36</b>
Expansion Joints .....	16	4" Fascia.....	35
Slip Joints .....	16	6" Fascia.....	35
<b>End Caps</b> .....	<b>17</b>	8" Fascia.....	36
<b>Hangers.....</b>	<b>18-19</b>	10" Fascia .....	36
Hidden .....	18	<b>Soffit</b> .....	<b>37</b>
Wrap Around .....	19	12" Premium Hidden Vent Soffit .....	37
T-Bar.....	19	12" Double 6 D6 Soffit.....	37
Vampire.....	19	12" Soffit .....	37
Hangers with Screws .....	20	16" Soffit .....	37
<b>Rainware Accessories.....</b>	<b>20-21</b>	<b>Siding Accessories.....</b>	<b>38-40</b>
T-Wedges & Gutter Wedges .....	20	F-Channel .....	38
Spikes .....	20	J-Channel.....	38
Ferrules .....	21	Miter Divider .....	38
Fascia Brackets.....	21	Siders Edge.....	39
Drive Pins .....	21	Starter Strip.....	39
<b>Round/Half Round Products</b> .....	<b>22</b>	Z-Flashing.....	39
Half Round Gutters.....	22	Drip Cap .....	40
Round Downspouts.....	22	<b>Warranties</b> .....	<b>41-43</b>
<b>Round/Half Round Products</b> .....	<b>23-24</b>		
Round Elbows .....	23		
Round Offsets.....	23		
Half Round Outlets .....	24		
Half Round Miters.....	24		

**PROUDLY FINISHED WITH**  
**SHERWIN-WILLIAMS.**  
**Coil Coatings**

**To place orders for metal products, please call:**  
 Beloit Plant Customer Service: **Ph 877-279-5096 • Fax 608-365-0493**  
[www.acm-metals.com](http://www.acm-metals.com)

For siding and window inquiries, please call Norandex™ Corporate Customer Service at **800-528-0942**

# Rainware Components & Accessories



## NORANDEX™

EXTERIOR PRODUCTS FOR YOUR HOME

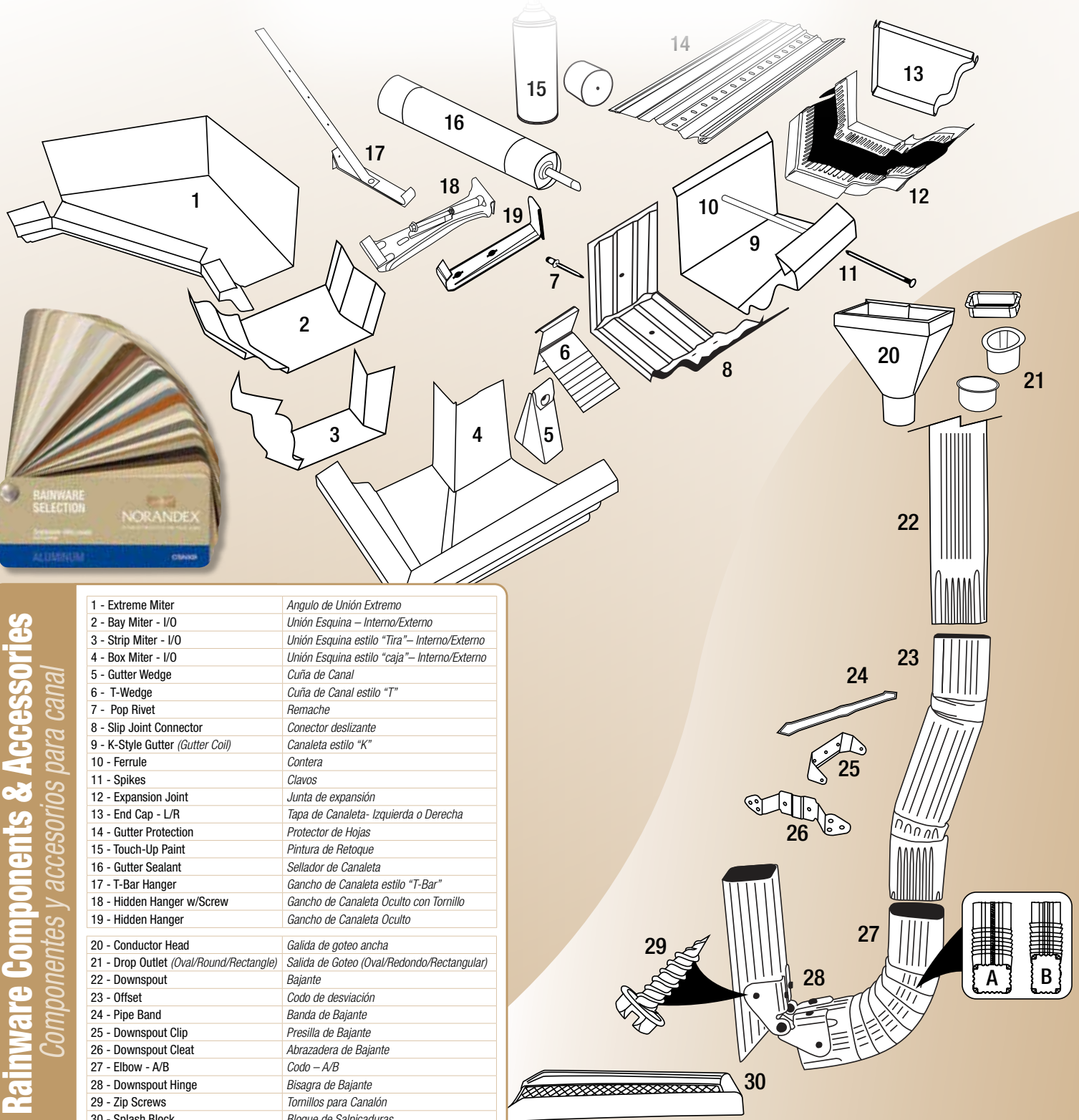

**Rainware Components & Accessories**  
Componentes y accesorios para canal

1 - Extreme Miter	Angulo de Unión Extremo
2 - Bay Miter - I/O	Unión Esquina - Interno/Externo
3 - Strip Miter - I/O	Unión Esquina estilo "Tira" - Interno/Externo
4 - Box Miter - I/O	Unión Esquina estilo "caja" - Interno/Externo
5 - Gutter Wedge	Cuña de Canal
6 - T-Wedge	Cuña de Canal estilo "T"
7 - Pop Rivet	Remache
8 - Slip Joint Connector	Conector deslizante
9 - K-Style Gutter (Gutter Coil)	Canaleta estilo "K"
10 - Ferrule	Contera
11 - Spikes	Clavos
12 - Expansion Joint	Junta de expansión
13 - End Cap - L/R	Tapa de Canaleta- Izquierda o Derecha
14 - Gutter Protection	Protector de Hojas
15 - Touch-Up Paint	Pintura de Retoque
16 - Gutter Sealant	Sellador de Canaleta
17 - T-Bar Hanger	Gancho de Canaleta estilo "T-Bar"
18 - Hidden Hanger w/Screw	Gancho de Canaleta Oculto con Tornillo
19 - Hidden Hanger	Gancho de Canaleta Oculto
20 - Conductor Head	Galida de goteo ancha
21 - Drop Outlet (Oval/Round/Rectangle)	Salida de Goteo (Oval/Redondo/Rectangular)
22 - Downspout	Bajante
23 - Offset	Codo de desviación
24 - Pipe Band	Banda de Bajante
25 - Downspout Clip	Presilla de Bajante
26 - Downspout Cleat	Abrazadera de Bajante
27 - Elbow - A/B	Codo - A/B
28 - Downspout Hinge	Bisagra de Bajante
29 - Zip Screws	Tornillos para Canalón
30 - Splash Block	Bloque de Salpicaduras

# Aluminum RAINWARE Color Selection



  
**NORANDEX™**  
 EXTERIOR PRODUCTS FOR YOUR HOME



**Royal Brown**  
 RB / B6



**Printed Color Swatch** (for color accuracy you need actual metal)

**Color - Thru**



Offering select products in comparable matching colors through Gutter Coil, Rainware, Soffit/Fascia, Trim Coil or Edge Metal product lines.

**Steel**

**Also Available in Steel**



**Rainware Color Code / Trim Coil Color Code**

**Note:** Actual color may vary from this representation. Please refer to actual metal color swatches for color accuracy. Color appearance may change when viewed at different angles or in sunlight.

**SHERWIN-WILLIAMS.**  
 Coil Coatings

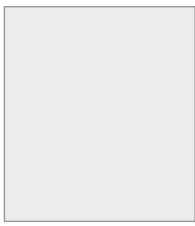

**Frost**  
FR

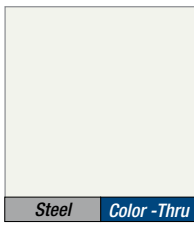

**30 Deg. White**  
WH / W1

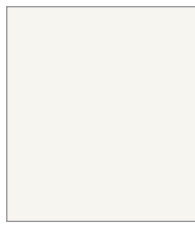

**80 Deg. White**  
80

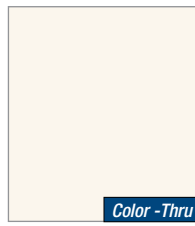

**NX Linen**  
LN / W10

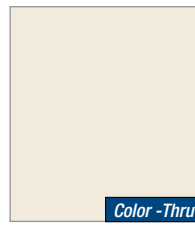

**Linen**  
Li / D4

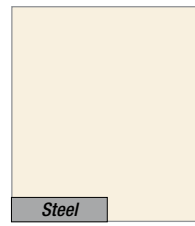

**Egg Shell**  
ES



**Cameo**  
CA / W2

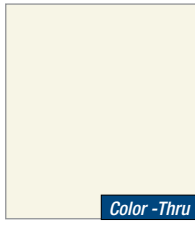

**NX Almond**  
AD / D49

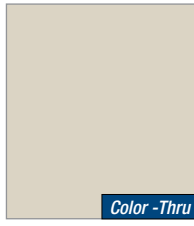

**NX Champagne**  
CH / D53

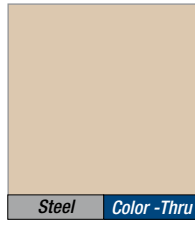

**Desert Sand**  
DS / D34

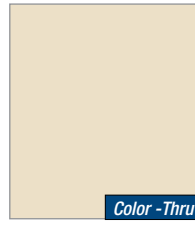

**Almond**  
AL / D14

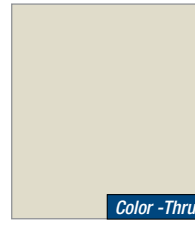

**NX Tan**  
TN / D48

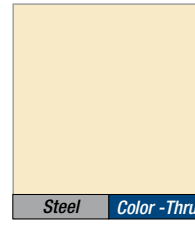

**Classic Cream**  
CC / D22



**Sandtone**  
ST / D6



**Wicker**  
Wi / D8

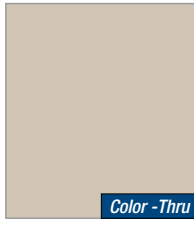

**NX Sand**  
SD / D51

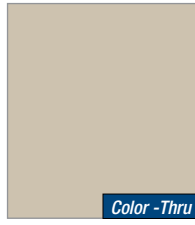

**NX Sand Stone**  
SS / D46



**NX Sierra Clay**  
Si / D47

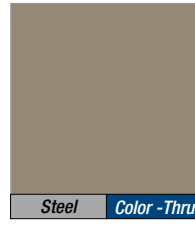

**Pebblestone Clay**  
PC / D5



**NX Russet**  
RT / B18



**Norwegian Wood**  
NW / D26



**Buckskin**  
BU / D27



**Montana Suede**  
MS / D44



**Terra Bronze**  
TB / B12



**Beaver Brown**  
BB / B5



**Royal Brown**  
RB / B6



**Musket Brown**  
MB / B1

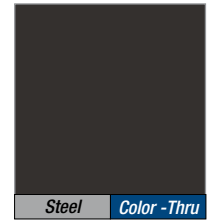

**Bronze**  
BZ / B13

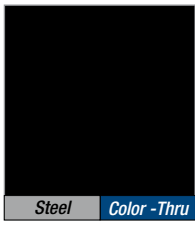

**Black**  
BK / A17



**Tuxedo Grey**  
TX



**Charcoal Grey**  
CG / A8

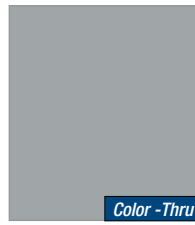

**NX Granite**  
GG / A19

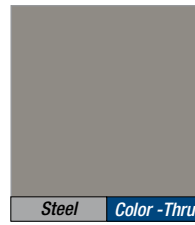

**Harbor Grey**  
HG / A2



**Victorian Grey**  
VG / A5

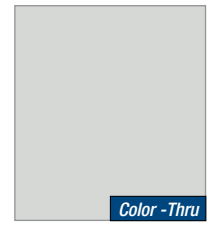

**Silver Grey**  
SG / A3

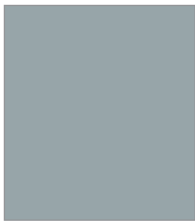

**Everest**  
EV / A15



**Country Blue**  
CU / L3

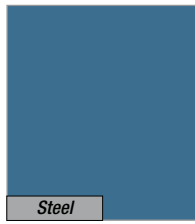

**Tahoe Blue**  
TA



**Evergreen**  
EG / G6

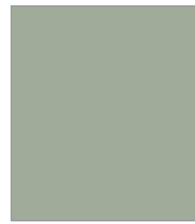

**Village Green**  
VI / G11



**Brookstone**  
BS / D21

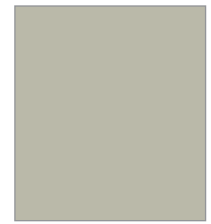

**Sage**  
SA / D25



**Rustic Copper**  
M2 (Premium Color)



**Copper Penny**  
CP



**Redwood**  
RW / R3



**NORANDEX**<sup>TM</sup>

EXTERIOR PRODUCTS FOR YOUR HOME

Aluminum **RAINWARE** Color Selection



## Gutter Coil Conversion Factors

(Determining Feet to Weight)

Coil Width	Nominal Thickness	Conversion Multiplier Formula			
11-3/4"	.027" Alum.	lin. ft. _____	X	.377 = _____	# lbs.
11-7/8"	.027" Alum.	lin. ft. _____	X	.380 = _____	# lbs.
14"	.027" Alum.	lin. ft. _____	X	.453 = _____	# lbs.
15"	.027" Alum.	lin. ft. _____	X	.476 = _____	# lbs.
11-3/4"	.032" Alum.	lin. ft. _____	X	.446 = _____	# lbs.
11-7/8"	.032" Alum.	lin. ft. _____	X	.450 = _____	# lbs.
13"	.032" Alum.	lin. ft. _____	X	.500 = _____	# lbs.
15"	.032" Alum.	lin. ft. _____	X	.571 = _____	# lbs.
18"	.032" Alum.	lin. ft. _____	X	.678 = _____	# lbs.
11-7/8"	26 ga. Steel	lin. ft. _____	X	.768 = _____	# lbs.
12"	26 ga. Steel	lin. ft. _____	X	.775 = _____	# lbs.
13"	26 ga. Steel	lin. ft. _____	X	.839 = _____	# lbs.
14"	26 ga. Steel	lin. ft. _____	X	.904 = _____	# lbs.
15"	26 ga. Steel	lin. ft. _____	X	.969 = _____	# lbs.
19"	26 ga. Steel	lin. ft. _____	X	1.23 = _____	# lbs.
11-7/8"	26 ga. Galvalume	lin. ft. _____	X	.72 = _____	# lbs.
15"	26 ga. Galvalume	lin. ft. _____	X	.90 = _____	# lbs.
11-7/8"	16 oz. Copper	lin. ft. _____	X	.99 = _____	# lbs.
15"	16 oz. Copper	lin. ft. _____	X	1.25 = _____	# lbs.

To process an order for a spin down quantity, determine the number of pounds based on the requested footage by the contractor. Enter the number of pounds on the ticket noting the required footage. After spinning down the required coil footage, re-weigh the coil to verify the actual pounds of coil taken out of inventory. Note the actual weight in shipped column of the ticket. Update the tickets to adjust the invoice accordingly. This process ensures proper invoicing and accurate inventory levels.

These coils are cut from master coils which are slightly thicker in the middle to avoid oil canning during the painting process. The gauge can vary slightly depending on where the coil was cut from the master coil. Inventory will vary if the product is sold by footage and not weight. Remember, product is purchased by the pound. Re-weighing is necessary for accuracy.

### A NOTE ABOUT COLOR SELECTION

NORANDEX™ provides color chip cards which show a close representation of the color. The purpose of color chip cards is to narrow down the homeowner choice of colors. Depending upon the substrate, the final selection should always be based on either an aluminum or steel color tile fan deck, viewed in full sunlight.

Metallic colors, such as Copper Penny (CP), Bronze (BZ), Rustic Copper (M2), and Weathered Bronze (WB), have mica (refractive) or aluminum (reflective) flakes added to the paint finish. The color of different products may be the same (as measured on a colorimeter), but the visual appearance may look slightly different when viewed from different angles and varying amount of sunlight. This is a normal occurring phenomenon and is due the chance positioning of the mica and aluminum flakes when added to the paint finish.



# NORANDEX™ Gutters

BELOIT PLANT

**Gutter Coil**

Part #	Description	Colors	Nom. Gauge/ Thickness	Rolls/ Pallet
AGC21134 - -	Aluminum 11'3/4" Coil	AL, BB, BK, BZ, BU, CA, CH, CG, CC, CP, CU, DS, ES, EV, EG, FR, GG, HG, LN, LI, MS, MB, NW, PC, RW, RB, RT, M2, SA, SD, SS, ST, SI, SG, TN, TB, VG, VI, WI, WH, 80	0.027	3
AGC21178 - -	Aluminum 11'7/8" Coil	AL, BB, BK, BZ, BS, BU, CA, CH, CG, CC, CP, CU, DS, EV, EG, FR, HG, LN, LI, MS, MB, NW, PC, M3, RW, RB, M2, SD, SS, ST, SI, TB, VG, VI, WI, WH, 80	0.027	3
AGC215 - -	Aluminum 15" Coil	AL, BB, BK, BZ, BS, BU, CA, CH, CG, CC, CP, CU, DS, ES, EV, EG, FR, GG, HG, LN, LI, MS, MB, NW, PC, RW, RB, RT, M2, SD, SS, ST, SI, SG, TN, TB, VG, VI, WI, WH, 80	0.027	2
AGC31134 - -	Aluminum 11'3/4" Coil	AL, BK, BZ, BS, BU, CA, CH, CG, CC, CP, CU, DS, EV, EG, FR, GG, HG, LN, LI, MS, MB, NW, PC, RW, RB, RT, M2, SD, SS, ST, SI, G, TN, TB, VG, VI, WI, WH, 80	0.032	3
AGC31178 - -	Aluminum 11'7/8" Coil	AD, AL, BB, BK, BZ, BS, BU, CA, CH, CG, CC, CP, CU, DS, ES, EV, EG, FR, GG, HG, LN, LI, MS, MB, NW, PC, RW, RB, M2, SA, SD, SS, ST, SI, SG, TB, VG, VI, WI, WH, 80	0.032	3
AGC315 - -	Aluminum 15" Coil	AL, BB, BK, BZ, BS, BU, CA, CH, CG, CC, CP, CU, DS, ES, EV, EG, FR, GG, HG, LN, LI, MS, MB, NW, PC, RW, RB, RT, M2, SA, SD, ST, SI, SG, TN, TB, VG, VI, WI, WH, 80	0.032	2
*AGC318 - - - -	Aluminum 18" Coil	BZ/FR, RB/WH	0.032	2
GGC114 - -	Galv. 11'7/8" Coil	PR, WH	26 ga	2
GGC114 - - - -	Galv. 11'7/8" Coil	BB/WH, CC/WH, CG/HG, DS/WH, EG/WH, ES/BZ, HV/WH, MB/WH, PC/WH, RB/WH, RW/BK, TA/CU, VG/WH, WI/WH	26 ga	2
GGC154 - -	Galv. 15" Coil	PR, WH	26 ga	2
GGC154 - - - -	Galv. 15" Coil	BB/WH, CC/WH, CG/HG, DS/WH, EG/WH, ES/BZ, HV/WH, MB/WH, PC/WH, RB/WH, RW/BK, TA/CU, VG/WH, WI/WH	26 ga	2

\*18" Gutter Coil cannot be sold in spin down quantities.

## Rainware & Accessories Aluminum Colors | ● = Color-Thru System™

COLOR	CODE	COLOR	CODE	COLOR	CODE	COLOR	CODE	COLOR	CODE
• NX ALMOND	AD	• CLASSIC CREAM	CC	• NX GRANITE	GG	• REDWOOD	RW	• NX SIERRA CLAY	SI
• ALMOND	AL	• COPPER PENNY	CP	• HARBOR GREY	HG	• ROYAL BROWN	RB	• NX SILVER/SILVER GREY	SG
• BEAVER BROWN	BB	• COUNTRY BLUE	CU	• NX LINEN	LN	• NX RUSSET	RT	• NX TAN	TN
• BLACK	BK	• DESERT SAND	DS	• LINEN	LI	★ RUSTIC COPPER	M2	• TERRA BRONZE	TB
• BRONZE	BZ	• EGG SHELL	ES	• MONTANA SUEDE	MS	• SAGE	SA	• VICTORIAN GREY	VG
• BROOKSTONE	BS	• EVEREST	EV	• MUSKET BROWN	MB	• NX SAND	SD	• VILLAGE GREEN	VI
• BUCKSKIN	BU	• EVERGREEN	EG	• NORWEGIAN WOOD	NW	• SANDTONE	ST	• WICKER	WI
• CAMEO	CA	• FROST	FR	• PEBBLESTONE CLAY	PC			• 30 WHITE	WH
• NX CHAMPAGNE	CH							• 80 WHITE	80
• CHARCOAL GREY	CG								

★ Rustic Copper is a PREMIUM color. NOTE: Rustic Copper (M2) accessories, including miters and end caps, may display paint finish variations due to the metallic painting process, which may affect matching components.

## Rainware Steel Colors:

COLOR	CODE	COLOR	CODE	COLOR	CODE	COLOR	CODE	COLOR	CODE
BEAVER BROWN	BB	CLASSIC CREAM	CC	EVERGREEN	EG	PEBBLESTONE CLAY	PC	TAHOE BLUE	TA
BLACK	BK	COUNTRY BLUE	CU	HARBOR GREY	HG	PRIME	PR	VICTORIAN GREY	VG
BRONZE	BZ	DESERT SAND	DS	HARVEST BROWN	HV	REDWOOD	RW	WICKER	WI
CHARCOAL GREY	CG	EGGSHELL	ES	MUSKET BROWN	MB	ROYAL BROWN	RB	30 WHITE	WH



# NORANDEX Gutters

BELOIT PLANT

## Spin Down Gutter Coil



Part #	Description	Colors	Nom. Gauge/ Thickness	Pieces/ Pound
ASC21134 - -	Aluminum 11'3/4" Coil	AL, BB, BK, BZ, BU, CA, CH, CG, CC, CP, CU, DS, ES, EV, EG, FR, GG, HG, LN, LI, MS, MB, NW, PC, RW, RB, RT, M2, SA, SD, SS, ST, SI, SG, TN, TB, VG, VI, WI, WH, 80	0.027	Order by the lb.
ASC21178 - -	Aluminum 11'7/8" Coil	AL, BB, BK, BZ, BS, BU, CA, CH, CG, CC, CP, CU, DS, EV, EG, FR, HG, LN, LI, MS, MB, NW, PC, M3, RW, RB, M2, SD, SS, ST, SI, TB, VG, VI, WI, WH, 80	0.027	Order by the lb.
ASC215 - -	Aluminum 15" Coil	AL, BB, BK, BZ, BS, BU, CA, CH, CG, CC, CP, CU, DS, ES, EV, EG, FR, GG, HG, LN, LI, MS, MB, NW, PC, RW, RB, RT, M2, SD, SS, ST, SI, SG, TN, TB, VG, VI, WI, WH, 80	0.027	Order by the lb.
ASC31134 - -	Aluminum 11'3/4" Coil	AL, BK, BZ, BS, BU, CA, CH, CG, CC, CP, CU, DS, EV, EG, FR, GG, HG, LN, LI, MS, MB, NW, PC, RW, RB, RT, M2, SD, SS, ST, SI, G, TN, TB, VG, VI, WI, WH, 80	0.032	Order by the lb.
ASC31178 - -	Aluminum 11'7/8" Coil	AD, AL, BB, BK, BZ, BS, BU, CA, CH, CG, CC, CP, CU, DS, ES, EV, EG, FR, GG, HG, LN, LI, MS, MB, NW, PC, RW, RB, M2, SA, SD, SS, ST, SI, SG, TB, VG, VI, WI, WH, 80	0.032	Order by the lb.
ASC315 - -	Aluminum 15" Coil	AL, BB, BK, BZ, BS, BU, CA, CH, CG, CC, CP, CU, DS, ES, EV, EG, FR, GG, HG, LN, LI, MS, MB, NW, PC, RW, RB, RT, M2, SA, SD, ST, SI, SG, TN, TB, VG, VI, WI, WH, 80	0.032	Order by the lb.
GSC61178WH	Galvanized 11'7/8" Coil	WH	26 ga	Order by the lb.
GSC61178PR	Galvanized 11'7/8" Coil	PR	26 ga	Order by the lb.
GSC611 - - - -	Galvanized 11'7/8" Coil	BB/WH, CC/WH, CG/HG, DS/WH, EG/WH, ES/BZ, HV/WH, MB/WH, PC/WH, RB/WH, RW/BK, TA/CU, VG/WH, WI/WH	26 ga	Order by the lb.
GSC154 - -	Galvanized 15" Coil	PR, WH	26 ga	Order by the lb.
GSC154 - - - -	Galvanized 15" Coil	BB/WH, CC/WH, CG/HG, DS/WH, EG/WH, ES/BZ, HV/WH, MB/WH, PC/WH, RB/WH, RW/BK, TA/CU, VG/WH, WI/WH	26 ga	Order by the lb.
LSC61178	Galvalume 11'7/8" Coil	Mill	26 ga	Order by the lb.
LSC615	Galvalume 15" Coil	Mill	26 ga	Order by the lb.
CSC21178	Copper 11'7/8" Coil	Copper	16 oz	Order by the lb.
CSC215	Copper 15" Coil	Copper	16 oz	Order by the lb.

**Note: Min. of 25 lbs./  
Max. of 150 lbs.**  
As an extra service, we'll spin down small quantities of a slow moving color on a special order basis. Minimum quantity is 25 lbs. Please note, once order is activated, no returns or changes can be made.

## Rainware & Accessories Aluminum Colors | • = Color-Thru System™

COLOR	CODE	COLOR	CODE	COLOR	CODE	COLOR	CODE	COLOR	CODE
• NX ALMOND	AD	• CLASSIC CREAM	CC	• NX GRANITE	GG	• REDWOOD	RW	• NX SIERRA CLAY	SI
• ALMOND	AL	• COPPER PENNY	CP	• HARBOR GREY	HG	• ROYAL BROWN	RB	• NX SILVER/SILVER GREY	SG
• BEAVER BROWN	BB	• COUNTRY BLUE	CU	• NX LINEN	LN	• NX RUSSET	RT	• NX TAN	TN
• BLACK	BK	• DESERT SAND	DS	• LINEN	LI	*RUSTIC COPPER	M2	• TERRA BRONZE	TB
• BRONZE	BZ	EGG SHELL	ES	MONTANA SUEDE	MS	SAGE	SA	• VICTORIAN GREY	VG
• BROOKSTONE	BS	EVEREST	EV	• MUSKET BROWN	MB	• NX SAND	SD	VILLAGE GREEN	VI
• BUCKSKIN	BU	• EVERGREEN	EG	• NORWEGIAN WOOD	NW	• SANDTONE	ST	• WICKER	WI
• CAMEO	CA	FROST	FR	• PEBBLESTONE CLAY	PC			• 30 WHITE	WH
• NX CHAMPAGNE	CH							80 WHITE	80
• CHARCOAL GREY	CG								

\*Rustic Copper is a PREMIUM color. NOTE: Rustic Copper (M2) accessories, including miters and end caps, may display paint finish variations due to the metallic painting process, which may affect matching components.

## Rainware Steel Colors:

COLOR	CODE	COLOR	CODE	COLOR	CODE	COLOR	CODE	COLOR	CODE
BEAVER BROWN	BB	CLASSIC CREAM	CC	EVERGREEN	EG	PEBBLESTONE CLAY	PC	TAHOE BLUE	TA
BLACK	BK	COUNTRY BLUE	CU	HARBOR GREY	HG	PRIME	PR	VICTORIAN GREY	VG
BRONZE	BZ	DESERT SAND	DS	HARVEST BROWN	HV	REDWOOD	RW	WICKER	WI
CHARCOAL GREY	CG	EGGSHELL	ES	MUSKET BROWN	MB	ROYAL BROWN	RB	30 WHITE	WH





# NORANDEX™ Downspouts

BELOIT PLANT

## Downspouts

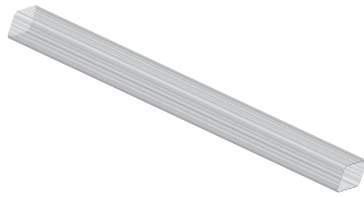

Part #	Description	Colors	Nom. Gauge/Thickness	Piece Length	Pieces/Box	Boxes/Pallet
ADS238 - -	Aluminum 2 x 3 x 8' DS	(Listed Below)	0.019	8'	10	28
ADS238M2	Aluminum 2 x 3 x 8' DS	M2 (Premium Color)	0.019	8'	10	28
ADS2310 - -	Aluminum 2 x 3 x 10' DS	(Listed Below)	0.019	10'	10	28
ADS2310M2	Aluminum 2 x 3 x 10' DS	M2 (Premium Color)	0.019	10'	10	28
ADS348 - -	Aluminum 3 x 4 x 8' DS	(Listed Below)	0.019	8'	10	15
ADS348M2	Aluminum 3 x 4 x 8' DS	M2 (Premium Color)	0.019	8'	10	15
ADS3410 - -	Aluminum 3 x 4 x 10' DS	(Listed Below)	0.019	10'	10	15
ADS3410M2	Aluminum 3 x 4 x 10' DS	M2 (Premium Color)	0.019	10'	10	15
ADS23410 - -	Aluminum 3 x 4 x 10' DS	AL, BK, BZ, CA, CG, CC, EG, FR, MB, NW, PC, RW, RB, SI, TB, WH, 80, WI	0.024	10'	10	15
ADS24510 - -	Aluminum 4 x 5 x 10' DS	AL, AI, BK, BZ, CC, CG, ES, FR, MB, RB, ST, SI, TB, WH, 80, WI	0.027	10'	6	15
GDS8238 - -	Galvanized 2 x 3 x 8' Corrugated	(Steel Colors)	28 ga	8'	10	
GDS8238PR	Galvanized 2 x 3 x 8' Corrugated	Prime	28 ga	8'	10	
GDS82310 - -	Galvanized 2 x 3 x 10' Corrugated	(Steel Colors)	28 ga	10'	10	
GDS82310PR	Galvanized 2 x 3 x 10' Corrugated	Prime	28 ga	10'	10	
GDS82310ML	Galvanized 2 x 3 x 10' Corrugated	Mill	28 ga	10'	10	
GDS63410 - -	Galvanized 3 x 4 Corrugated	(Steel Colors)	26 ga	10'	5	
GDS63410PR	Galvanized 3 x 4 Corrugated	Prime	26 ga	10'	5	
GDS63410ML	Galvanized 3 x 4 Corrugated	Mill	26 ga	10'	5	
LDS238	Galvalume 2 x 3 x 8' DS	Mill	26 ga	10'	10	
LDS2310	Galvalume 2 x 3 x 10' DS	Mill	26 ga	10'	10	
LDS348	Galvalume 3 x 4 x 8' DS	Mill	26 ga	10'	10	
LDS3410	Galvalume 3 x 4 x 10' DS	Mill	26 ga	10'	5	
CDS2310	Copper 2 x 3 x 10' DS	Copper	16 oz	10'	Order by the pc.	
CDS3410	Copper 3 x 4 x 10' DS	Copper	16 oz	10'	Order by the pc.	

ADS2310, CDS2310

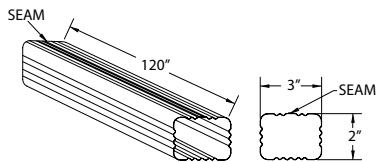

ADS3410, ADS23410, CDS3410

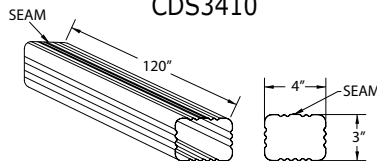

ADS24510

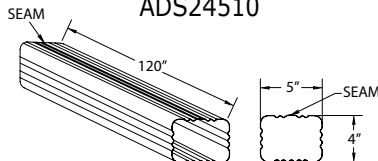

GDS82310

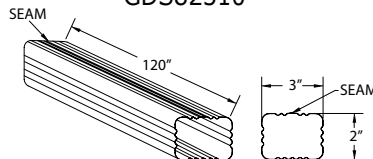

GDS63410

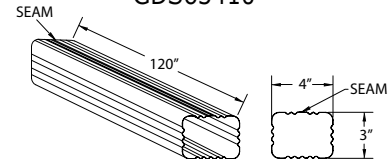

## Rainware & Accessories Aluminum Colors | ●=Color-Thru System™

COLOR	CODE	COLOR	CODE	COLOR	CODE	COLOR	CODE	COLOR	CODE
● NX ALMOND	AD	● CLASSIC CREAM	CC	● NX GRANITE	GG	● REDWOOD	RW	● NX SIERRA CLAY	SI
● ALMOND	AL	● COPPER PENNY	CP	● HARBOR GREY	HG	● ROYAL BROWN	RB	● NX SILVER/SILVER GREY	SG
● BEAVER BROWN	BB	● COUNTRY BLUE	CU	● JEFFERSON TAN	JT	● NX RUSSET	RT	● NX TAN	TN
● BLACK	BK	● DESERT SAND	DS	● NX LINEN	LN	● RUSTIC COPPER	M2	● TERRA BRONZE	TB
● BRONZE	BZ	● EGG SHELL*	ES	● LINEN	LI	★ SAGE*	SA	● VICTORIAN GREY	VG
● BROOKSTONE	BS	● EVEREST	EV	● MONTANA SUEDE	MS	● NX SAND	SD	● VILLAGE GREEN	VI
● BUCKSKIN	BU	● EVERGREEN	EG	● MUSKET BROWN	MB	● NX SAND STONE	SS	● WICKER	WI
● CAMEO	CA	● FROST	FR	● NORWEGIAN WOOD	NW	● SANDTONE	ST	● 30 WHITE	WH
● NX CHAMPAGNE	CH			● PEBBLESTONE CLAY	PC			● 80 WHITE	80
● CHARCOAL GREY	CG								

★Rustic Copper is a PREMIUM color. NOTE: Rustic Copper (M2) accessories, including miters and end caps, may display paint finish variations due to the metallic painting process, which may affect matching components.

## Rainware Steel Colors:

COLOR	CODE	COLOR	CODE	COLOR	CODE	COLOR	CODE	COLOR	CODE
BEAVER BROWN	BB	CLASSIC CREAM	CC	EVERGREEN	EG	PEBBLESTONE CLAY	PC	TAHOE BLUE	TA
BLACK	BK	COUNTRY BLUE	CU	HARBOR GREY	HG	PRIME	PR	VICTORIAN GREY	VG
BRONZE	BZ	DESERT SAND	DS	HARVEST BROWN	HV	REDWOOD	RW	WICKER	WI
CHARCOAL GREY	CG	EGGSHELL	ES	MUSKET BROWN	MB	ROYAL BROWN	RB	30 WHITE	WH



# NORANDEX™ Elbows

BELOIT PLANT

## Elbows



Part #	Description	Colors	Nom. Gauge/ Thickness	Piece Length	Pieces/ Box	Boxes/ Pallet
AAE23 - -	Aluminum 2 x 3 A's	(Listed Below)	0.019	10-9/16"	30	32
AAE23M2	Aluminum 2 x 3 A's	M2 (Premium Color)	0.019	10-9/16"	30	32
ABE23 - -	Aluminum 2 x 3 B's	(Listed Below)	0.019	11-1/2"	30	32
ABE23M2	Aluminum 2 x 3 B's	M2 (Premium Color)	0.019	11-1/2"	30	32
AAE34 - -	Aluminum 3 x 4 A's	(Listed Below)	0.019	12-3/4"	30	16
AAE34M2	Aluminum 3 x 4 A's	M2 (Premium Color)	0.019	12-3/4"	30	16
ABE34 - -	Aluminum 3 x 4 B's	(Listed Below)	0.019	15"	30	16
ABE34M2	Aluminum 3 x 4 B's	M2 (Premium Color)	0.019	15"	30	16
AAE234 - -	Aluminum 3 x 4 A's	AL, BK, BZ, CA, CG, CC, EG, FR, MB, NW, PC, RW, RB, SI, TB, WH, 80, WI	0.024	12-3/4"	30	16
ABE234 - -	Aluminum 3 x 4 B's	AL, BK, BZ, CA, CG, CC, EG, FR, MB, NW, PC, RW, RB, SI, TB, WH, 80, WI	0.024	15"	30	16
AAE245 - -	Aluminum 4 x 5 A's	AL, AI, BK, BZ, CC, CG, ES, FR, MB, RB, ST, SI, TB, WH, 80, WI	0.027	15-1/2"	9	12
ABE245 - -	Aluminum 4 x 5 B's	AL, AI, BK, BZ, CC, CG, ES, FR, MB, RB, ST, SI, TB, WH, 80, WI	0.027	15-3/4"	9	12

AAE23 A-Elbow

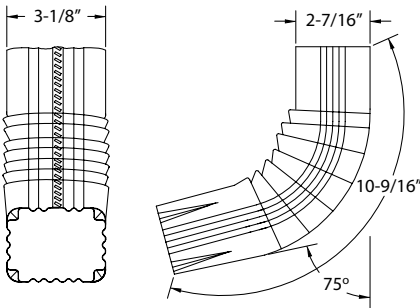

ABE23 B-Elbow

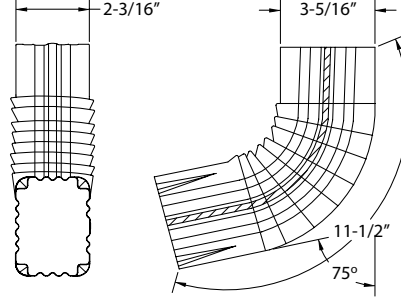

AAE34, AAE234 A-Elbow

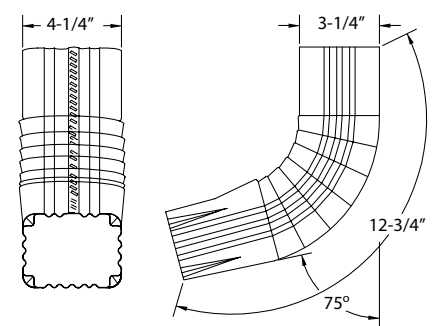

ABE34, ABE234 B-Elbow

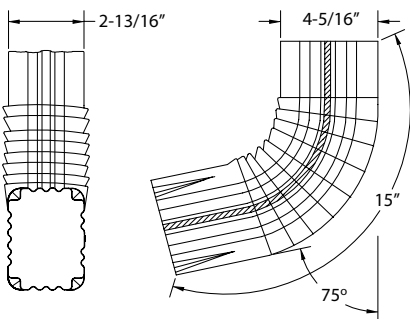

AAE245 A-Elbow

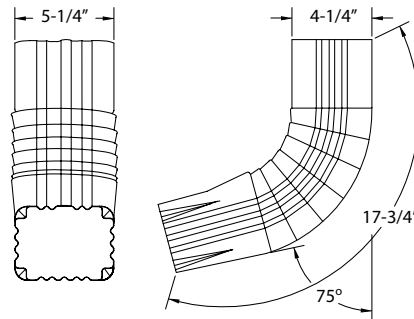

ABE245 B-Elbow

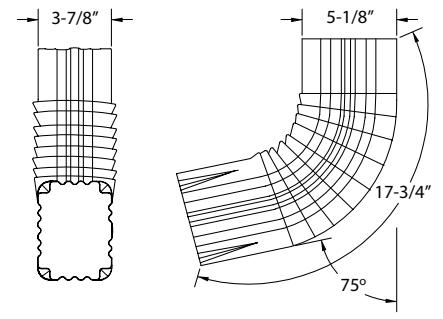

### Rainware & Accessories Aluminum Colors | ● = Color-Thru System™

COLOR	CODE	COLOR	CODE	COLOR	CODE	COLOR	CODE	COLOR	CODE
● NX ALMOND	AD	● CLASSIC CREAM	CC	● NX GRANITE	GG	● REDWOOD	RW	● NX SIERRA CLAY	SI
● ALMOND	AL	● COPPER PENNY	CP	● HARBOR GREY	HG	● ROYAL BROWN	RB	● NX SILVER/SILVER GREY	SG
● BEAVER BROWN	BB	● COUNTRY BLUE	CU	● JEFFERSON TAN	JT	● NX RUSSET	RT	● NX TAN	TN
● BLACK	BK	● DESERT SAND	DS	● NX LINEN	LN	● RUSTIC COPPER	M2	● TERRA BRONZE	TB
● BRONZE	BZ	● EGG SHELL*	ES	● LINEN	LI	★ SAGE*	SA	● VICTORIAN GREY	VG
● BROOKSTONE	BS	● EVEREST	EV	● MONTANA SUEDE	MS	● NX SAND	SD	● VILLAGE GREEN	VI
● BUCKSKIN	BU	● EVERGREEN	EG	● MUSKET BROWN	MB	● NX SAND STONE	SS	● WICKER	WI
● CAMEO	CA	● FROST	FR	● NORWEGIAN WOOD	NW	● SANDTONE	ST	● 30 WHITE	WH
● NX CHAMPAGNE	CH			● PEBBLESTONE CLAY	PC			● 80 WHITE	80
● CHARCOAL GREY	CG								

★Rustic Copper is a PREMIUM color. NOTE: Rustic Copper (M2) accessories, including miters and end caps, may display paint finish variations due to the metallic painting process, which may affect matching components.



# NORANDEX™ Elbows

BELOIT PLANT

**Elbows cont.**



Part #	Description	Colors	Nom. Gauge/ Thickness	Piece Length	Pieces/ Box	Boxes/ Pallet
GAE823 - -	Galv. 2 x 3 A Corrugated	(Steel Colors)	28 ga	10-9/16"	30	32
GBE823 - -	Galv. 2 x 3 B Corrugated	(Steel Colors)	28 ga	11-1/2"	30	32
GAE823PR	Galv. 2 x 3 A Corrugated	Prime	28 ga	10-9/16"	30	32
GBE823PR	Galv. 2 x 3 B Corrugated	Prime	28 ga	11-1/2"	30	32
GAE823ML	Galv. 2 x 3 A Corrugated	Mill	28 ga	10-9/16"	30	32
GBE823ML	Galv. 2 x 3 B Corrugated	Mill	28 ga	11-1/2"	30	32
GAE634 - -	Galv. 3 x 4 A Corrugated	(Steel Colors)	26 ga	12-3/4"	30	16
GBE634 - -	Galv. 3 x 4 B Corrugated	(Steel Colors)	26 ga	15"	30	16
GAE634PR	Galv. 3 x 4 A Corrugated	Prime	26 ga	12-3/4"	30	16
GBE634PR	Galv. 3 x 4 B Corrugated	Prime	26 ga	15"	30	16
GAE634ML	Galv. 3 x 4 A Corrugated	Mill	26 ga	12-3/4"	30	16
GBE634ML	Galv. 3 x 4 B Corrugated	Mill	26 ga	15"	30	16
LAE23	Galvalume 2 x 3 A's	Mill	26 ga	12-3/4"	30	16
LBE23	Galvalume 2 x 3 B's	Mill	26 ga	15"	30	16
LAE34	Galvalume 3 x 4 A's	Mill	26 ga	12-3/4"	30	16
LBE34	Galvalume 3 x 4 B's	Mill	26 ga	15"	30	16
CAE23	Copper 2 x 3 A's	Copper	16 oz	10-9/16"	Order by the pc.	
CBE23	Copper 2 x 3 B's	Copper	16 oz	11-1/2"	Order by the pc.	
CAE34	Copper 3 x 4 A's	Copper	16 oz	12-3/4"	Order by the pc.	
CBE34	Copper 3 x 4 B's	Copper	16 oz	15"	Order by the pc.	

**NOTE:** Rustic Copper (M2) accessories, including miters and end caps, may display paint finish variations due to the metallic painting process, which may affect matching components.

GAE823, CAE23 A-Elbow

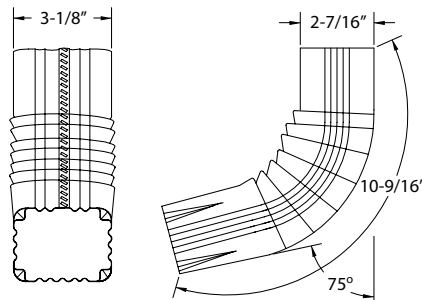

GBE823, CAE23 B-Elbow

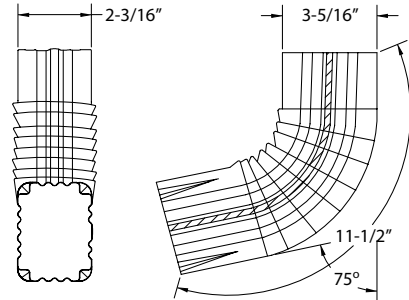

GAE634, CAE34 A-Elbow

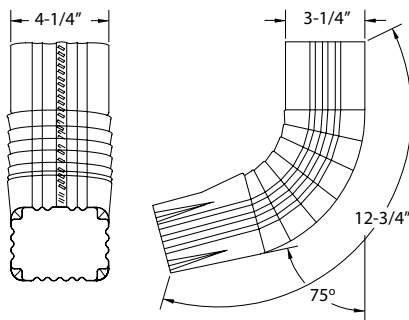

GBE634, CBE34 B-Elbow

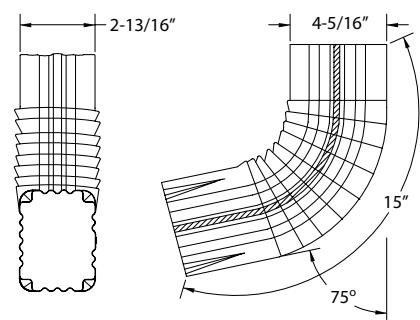

**Rainware Steel Colors:**

COLOR	CODE	COLOR	CODE	COLOR	CODE	COLOR	CODE	COLOR	CODE
BEAVER BROWN	BB	CLASSIC CREAM	CC	EVERGREEN	EG	PEBBLESTONE CLAY	PC	TAHOE BLUE	TA
BLACK	BK	COUNTRY BLUE	CU	HARBOR GREY	HG	PRIME	PR	VICTORIAN GREY	VG
BRONZE	BZ	DESERT SAND	DS	HARVEST BROWN	HV	REDWOOD	RW	WICKER	WI
CHARCOAL GREY	CG	EGGSHELL	ES	MUSKET BROWN	MB	ROYAL BROWN	RB	30 WHITE	WH



# NORANDEX™ Variable Degree Elbows

BELOIT PLANT

## Variable Degree Elbows

This chart shows the roof pitch paired to the approximate variable degree elbow.

ROOF PITCH	DEGREE	CRIMP QTY.
Mansard	15°	1
18/12	22°	2
16/12	22°	2
14/12	22°	2
12/12	30°	3
10/12	45°	4
8/12	45°	4
6/12	45°	4
4/12	75°	7

Variable degree elbows are used to go around obstructions (ledge jumpers) or transition to the slope of the roof. Number of crimps to create angle can vary with manufacturer.

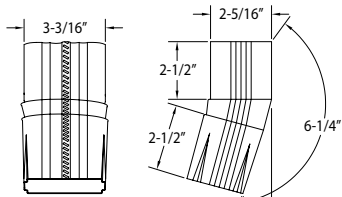

AAE123 A-Elbow

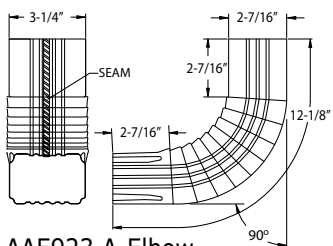

AAE923 A-Elbow

Part #	Description	Colors	Nom. Gauge/ Thickness	Pieces/ Box	Boxes/ Pallet
AAE123 - -	Aluminum 2 x 3 A's 15°	*(Listed Below)	0.019	30	32
AAE2223 - -	Aluminum 2 x 3 A's 22°	*(Listed Below)	0.019	30	16
AAE323 - -	Aluminum 2 x 3 A's 30°	*(Listed Below)	0.019	30	16
AAE423 - -	Aluminum 2 x 3 A's 45°	*(Listed Below)	0.019	30	16
AAE923 - -	Aluminum 2 x 3 A's 90°	*(Listed Below)	0.019	30	16
AAE134 - -	Aluminum 3 x 4 A's 15°	*(Listed Below)	0.019	30	6
AAE2234 - -	Aluminum 3 x 4 A's 22°	*(Listed Below)	0.019	30	16
AAE334 - -	Aluminum 3 x 4 A's 30°	*(Listed Below)	0.019	30	8
AAE434 - -	Aluminum 3 x 4 A's 45°	*(Listed Below)	0.019	30	16
AAE934 - -	Aluminum 3 x 4 A's 90°	*(Listed Below)	0.019	30	16
AAE2445 - -	Aluminum 4 x 5 A's 45°	AL, AI, BK, BZ, CC, CG, ES, FR, MB, RB, ST, SI, TB, WH, 80, WI	0.027	9	20
ABE123 - -	Aluminum 2 x 3 B's 15°	*(Listed Below)	0.019	30	32
ABE2223 - -	Aluminum 2 x 3 B's 22°	*(Listed Below)	0.019	30	16
ABE323 - -	Aluminum 2 x 3 B's 30°	*(Listed Below)	0.019	30	16
ABE423 - -	Aluminum 2 x 3 B's 45°	*(Listed Below)	0.019	30	16
ABE923 - -	Aluminum 2 x 3 B's 90°	*(Listed Below)	0.019	30	16
ABE134 - -	Aluminum 3 x 4 B's 15°	*(Listed Below)	0.019	30	6
ABE2234 - -	Aluminum 3 x 4 B's 22°	*(Listed Below)	0.019	30	16
ABE334 - -	Aluminum 3 x 4 B's 30°	*(Listed Below)	0.019	30	6
ABE434 - -	Aluminum 3 x 4 B's 45°	*(Listed Below)	0.019	30	16
ABE934 - -	Aluminum 3 x 4 B's 90°	*(Listed Below)	0.019	30	16
ABE2445 - -	Aluminum 4 x 5 B's 45°	AL, AI, BK, BZ, CC, CG, ES, FR, MB, RB, ST, SI, TB, WH, 80, WI	0.027	9	20
LAE334	Galvalume 3 x 4 A's 30°	Mill	26 ga	30	16
LAE434	Galvalume 3 x 4 A's 45°	Mill	26 ga	30	16

\*Note: Also available in premium color Rustic Copper (M2).

Galvanized 15°, 22°, 30°, & 45° elbows also available in steel colors listed below. Please check color availability with our Customer Service team.

Part #'s for "A" 2 x 3: 15° = GAE8123 - - 22° = GAE8223 - - 30° = GAE8323 - - 45° = GAE8423 - -  
 Part #'s for "B" 2 x 3: 15° = GBE8123 - - 22° = GBE8223 - - 30° = GBE8323 - - 45° = GBE8423 - -  
 Part #'s for "A" 3 x 4: 15° = GAE6134 - - 22° = GAE6234 - - 30° = GAE6334 - - 45° = GAE6434 - -  
 Part #'s for "B" 3 x 4: 15° = GBE6134 - - 22° = GBE6234 - - 30° = GBE6334 - - 45° = GBE6434 - -

## Rainware & Accessories Aluminum Colors | ● = Color-Thru System™

COLOR	CODE	COLOR	CODE	COLOR	CODE	COLOR	CODE	COLOR	CODE
● NX ALMOND	AD	● CLASSIC CREAM	CC	● NX GRANITE	GG	● REDWOOD	RW	● NX SIERRA CLAY	SI
● ALMOND	AL	● COPPER PENNY	CP	● HARBOR GREY	HG	● ROYAL BROWN	RB	● NX SILVER/SILVER GREY	SG
● BEAVER BROWN	BB	● COUNTRY BLUE	CU	● JEFFERSON TAN	JT	● NX RUSSET	RT	● NX TAN	TN
● BLACK	BK	● DESERT SAND	DS	● NX LINEN	LN	● RUSTIC COPPER	M2	● TERRA BRONZE	TB
● BRONZE	BZ	● EGG SHELL*	ES	● LINEN	LI	★ SAGE*	SA	● VICTORIAN GREY	VG
● BROOKSTONE	BS	● EVEREST	EV	● MONTANA SUEDE	MS	● NX SAND	SD	● VILLAGE GREEN	VI
● BUCKSKIN	BU	● EVERGREEN	EG	● MUSKET BROWN	MB	● NX SAND STONE	SS	● WICKER	WI
● CAMEO	CA	● FROST	FR	● NORWEGIAN WOOD	NW	● SANDTONE	ST	● 30 WHITE	WH
● NX CHAMPAGNE	CH			● PEBBLESTONE CLAY	PC			● 80 WHITE	80
● CHARCOAL GREY	CG								

\*Rustic Copper is a PREMIUM color. NOTE: Rustic Copper (M2) accessories, including miters and end caps, may display paint finish variations due to the metallic painting process, which may affect matching components.

## Rainware Steel Colors:

COLOR	CODE	COLOR	CODE	COLOR	CODE	COLOR	CODE	COLOR	CODE
BEAVER BROWN	BB	CLASSIC CREAM	CC	EVERGREEN	EG	PEBBLESTONE CLAY	PC	TAHOE BLUE	TA
BLACK	BK	COUNTRY BLUE	CU	HARBOR GREY	HG	PRIME	PR	VICTORIAN GREY	VG
BRONZE	BZ	DESERT SAND	DS	HARVEST BROWN	HV	REDWOOD	RW	WICKER	WI
CHARCOAL GREY	CG	EGGSHELL	ES	MUSKET BROWN	MB	ROYAL BROWN	RB	30 WHITE	WH



# NORANDEX™ Offsets

BELOIT PLANT

## Offsets

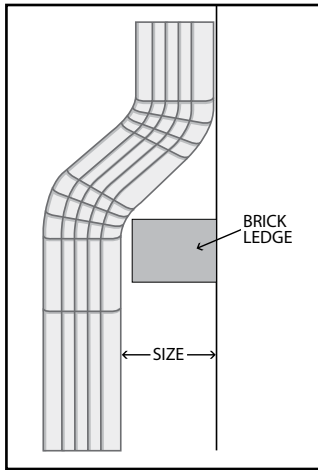

We have several varieties of offset downspout connections to transition gracefully over a brick ledge. You can eliminate the awkward look of a two-piece configuration with our choice of 1" to 6" away-from-the-wall options.

Part #	Description	Colors	Nom. Gauge/Thickness	Pieces/Box
ABO2A23A	Alum. Brickledge Offsets (2 pc.) 2 x 3 A's, 3 Crimps	(Listed Below)	0.019	18 sets
ABO2A23B	Alum. Brickledge Offsets (2 pc.) 2 x 3 B's, 3 Crimps	(Listed Below)	0.019	18 sets
ABO2A34A	Alum. Brickledge Offsets (2 pc.) 3 x 4 A's, 3 Crimps	*(Listed Below)	0.019	18 sets
ABO2A34B	Alum. Brickledge Offsets (2 pc.) 3 x 4 B's, 3 Crimps	*(Listed Below)	0.019	18 sets
ABO1123A	Aluminum 2 x 3 - 1" A's	(Listed Below)	0.019	24
ABO1123AM2	Aluminum 2 x 3 - 1" A's	M2 (Premium Color)	0.019	24
ABO1223A	Aluminum 2 x 3 - 2" A's	(Listed Below)	0.019	24
ABO1223AM2	Aluminum 2 x 3 - 2" A's	M2 (Premium Color)	0.019	24
ABO1323A	Aluminum 2 x 3 - 3" A's	(Listed Below)	0.019	24
ABO1323AM2	Aluminum 2 x 3 - 3" A's	M2 (Premium Color)	0.019	24
ABO1423A	Aluminum 2 x 3 - 4" A's	(Listed Below)	0.019	20
ABO1423AM2	Aluminum 2 x 3 - 4" A's	M2 (Premium Color)	0.019	20
ABO1523A	Aluminum 2 x 3 - 5" A's	(Listed Below)	0.019	20
ABO1623A	Aluminum 2 x 3 - 6" A's	(Listed Below)	0.019	20
ABO1134A	Aluminum 3 x 4 - 1" A's	(Listed Below)	0.019	24
ABO1134AM2	Aluminum 3 x 4 - 1" A's	M2 (Premium Color)	0.019	24
ABO1234A	Aluminum 3 x 4 - 2" A's	(Listed Below)	0.019	24
ABO1234AM2	Aluminum 3 x 4 - 2" A's	M2 (Premium Color)	0.019	24
ABO1334A	Aluminum 3 x 4 - 3" A's	(Listed Below)	0.019	24
ABO1334AM2	Aluminum 3 x 4 - 3" A's	M2 (Premium Color)	0.019	24
ABO1434A	Aluminum 3 x 4 - 4" A's	(Listed Below)	0.019	20
ABO1434AM2	Aluminum 3 x 4 - 4" A's	M2 (Premium Color)	0.019	20
ABO1534A	Aluminum 3 x 4 - 5" A's	(Listed Below)	0.019	20
ABO1634A	Aluminum 3 x 4 - 6" A's	(Listed Below)	0.019	20
ABO1634AM2	Aluminum 3 x 4 - 6" A's	M2 (Premium Color)	0.019	20
ABO1145A	Aluminum 4 x 5 - 1" A's	AL, AI, BK, BZ, CC, ES, FR, MB, RB, ST, SI, TB, WH, 80, WI	0.027	9
ABO1245A	Aluminum 4 x 5 - 2" A's	AL, AI, BK, BZ, CC, ES, FR, MB, RB, ST, SI, TB, WH, 80, WI	0.027	9
ABO1345A	Aluminum 4 x 5 - 3" A's	AL, AI, BK, BZ, CC, ES, FR, MB, RB, ST, SI, TB, WH, 80, WI	0.027	9
ABO1445A	Aluminum 4 x 5 - 4" A's	AL, AI, BK, BZ, CC, ES, FR, MB, RB, ST, SI, TB, WH, 80, WI	0.027	9
ABO1545A	Aluminum 4 x 5 - 5" A's	AL, AI, BK, BZ, CC, ES, FR, MB, RB, ST, SI, TB, WH, 80, WI	0.027	9
ABO1645A	Aluminum 4 x 5 - 6" A's	AL, AI, BK, BZ, CC, ES, FR, MB, RB, ST, SI, TB, WH, 80, WI	0.027	9

ABO1123A A-Offset

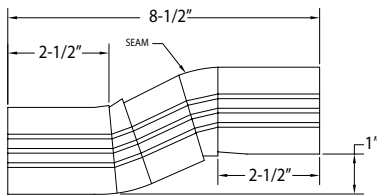

ABO1134A A-Offset

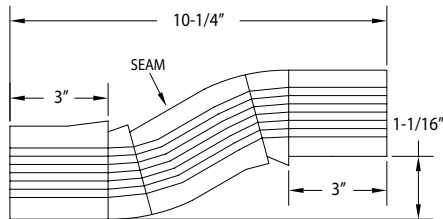

All "A" Offsets also available in "B" profiles.

\*Note: ABO2A34A/B not available in SI.

## Rainware & Accessories Aluminum Colors | ● = Color-Thru System™

COLOR	CODE	COLOR	CODE	COLOR	CODE	COLOR	CODE	COLOR	CODE
● NX ALMOND	AD	● CLASSIC CREAM	CC	● NX GRANITE	GG	● REDWOOD	RW	● NX SIERRA CLAY	SI
● ALMOND	AL	● COPPER PENNY	CP	● HARBOR GREY	HG	● ROYAL BROWN	RB	● NX SILVER/SILVER GREY	SG
● BEAVER BROWN	BB	● COUNTRY BLUE	CU	● JEFFERSON TAN	JT	● NX RUSSET	RT	● NX TAN	TN
● BLACK	BK	● DESERT SAND	DS	● NX LINEN	LN	● RUSTIC COPPER	M2	● TERRA BRONZE	TB
● BRONZE	BZ	● EGG SHELL*	ES	● LINEN	LI	● *SAGE*	SA	● VICTORIAN GREY	VG
● BROOKSTONE	BS	● EVEREST	EV	● MONTANA SUEDE	MS	● NX SAND	SD	● VILLAGE GREEN	VI
● BUCKSKIN	BU	● EVERGREEN	EG	● MUSKET BROWN	MB	● NX SAND STONE	SS	● WICKER	WI
● CAMEO	CA	● FROST	FR	● NORWEGIAN WOOD	NW	● SANDTONE	ST	● 30 WHITE	WH
● NX CHAMPAGNE	CH			● PEBBLESTONE CLAY	PC			● 80 WHITE	80
● CHARCOAL GREY	CG								

\*Rustic Copper is a PREMIUM color. NOTE: Rustic Copper (M2) accessories, including miters and end caps, may display paint finish variations due to the metallic painting process, which may affect matching components.



<b>Offsets cont.</b>		<b>Part #</b>	<b>Description</b>	<b>Colors</b>	<b>Nom. Gauge/ Thickness</b>	<b>Pieces/ Box</b>	<b>Boxes/ Pallet</b>
		GBO1123A --	Galvanized 2 x 3 - 1" A's	(Steel Colors)	26 ga	24	32
		GBO1223A --	Galvanized 2 x 3 - 2" A's	(Steel Colors)	26 ga	24	32
		GBO1323A --	Galvanized 2 x 3 - 3" A's	(Steel Colors)	26 ga	24	32
		GBO1423A --	Galvanized 2 x 3 - 4" A's	(Steel Colors)	26 ga	20	32
		GBO1234A --	Galvanized 3 x 4 - 2" A's	(Steel Colors)	26 ga	24	32
		GBO1334A --	Galvanized 3 x 4 - 3" A's	(Steel Colors)	26 ga	20	32
		GBO1334APR	Galvanized 3 x 4 - 3" A's	Prime	26 ga	20	32
		GBO1434A --	Galvanized 3 x 4 - 4" A's	(Steel Colors)	26 ga	20	32
		GBO1434APR	Galvanized 3 x 4 - 4" A's	Prime	26 ga	20	32
		LBO1123A	Galvalume 2 x 3 - 1" A's	Mill	26 ga	24	32
		LBO1223A	Galvalume 2 x 3 - 2" A's	Mill	26 ga	24	32
		LBO1323A	Galvalume 2 x 3 - 3" A's	Mill	26 ga	24	32
		LBO1423A	Galvalume 2 x 3 - 4" A's	Mill	26 ga	24	32
		LBO1623A	Galvalume 2 x 3 - 6" A's	Mill	26 ga	24	32
		LBO1134A	Galvalume 3 x 4 - 1" A's	Mill	26 ga	24	32
		LBO1234A	Galvalume 3 x 4 - 2" A's	Mill	26 ga	24	32
	LBO1334A	Galvalume 3 x 4 - 3" A's	Mill	26 ga	24	32	
	LBO1434A	Galvalume 3 x 4 - 4" A's	Mill	26 ga	24	32	
	LBO1534A	Galvalume 3 x 4 - 5" A's	Mill	26 ga	24	32	
	LBO1634A	Galvalume 3 x 4 - 6" A's	Mill	26 ga	24	32	
	CBO1223A	Copper 2 x 3 - 2" A's	Copper	16 oz	Order by the pc.		
	CBO1323A	Copper 2 x 3 - 3" A's	Copper	16 oz	Order by the pc.		
	CBO1423A	Copper 2 x 3 - 4" A's	Copper	16 oz	Order by the pc.		
	CBO1134A	Copper 3 x 4 - 1" A's	Copper	16 oz	Order by the pc.		
	CBO1234A	Copper 3 x 4 - 2" A's	Copper	16 oz	Order by the pc.		
	CBO1334A	Copper 3 x 4 - 3" A's	Copper	16 oz	Order by the pc.		
	CBO1434A	Copper 3 x 4 - 4" A's	Copper	16 oz	Order by the pc.		
	CBO1634A	Copper 3 x 4 - 6" A's	Copper	16 oz	Order by the pc.		

All "A" Offsets also available in "B" profiles.

<b>Conductor Heads</b>		<b>Part #</b>	<b>Description</b>	<b>Colors</b>	<b>Pieces/ Box</b>
		ACH3 --	Aluminum 3" Conductor Head	RB, WH	Order by the pc.
		ACH4 --	Aluminum 4" Conductor Head	RB, WH, 80	Order by the pc.
		CCH3	Copper 3" Conductor Head	Copper	Order by the pc.

ACH3

**Rainware Aluminum Colors:**

COLOR	CODE	COLOR	CODE	COLOR	CODE
ROYAL BROWN	RB	WHITE	WH	80 WHITE	80

**Rainware Steel Colors:**

COLOR	CODE	COLOR	CODE	COLOR	CODE	COLOR	CODE	COLOR	CODE
BEAVER BROWN	BB	CLASSIC CREAM	CC	EVERGREEN	EG	PEBBLESTONE CLAY	PC	TAHOE BLUE	TA
BLACK	BK	COUNTRY BLUE	CU	HARBOR GREY	HG	PRIME	PR	VICTORIAN GREY	VG
BRONZE	BZ	DESERT SAND	DS	HARVEST BROWN	HV	REDWOOD	RW	WICKER	WI
CHARCOAL GREY	CG	EGGSHELL	ES	MUSKET BROWN	MB	ROYAL BROWN	RB	30 WHITE	WH





# NORANDEX™ Downspout Accessories

BELOIT PLANT

Outlets		Part #	Description	Colors	Nom. Gauge/ Thickness	Pieces/ Box
Round Outlet 	AORE23ML	Aluminum 2 x 3 Rectangle Outlet	*	0.019	30	
	AORE34ML	Aluminum 3 x 4 Rectangle Outlet	*	0.019	50	
	AEORE34ML	Aluminum 3 x 4 Econ. Rectangle Outlet	*	0.016	50	
	AORE45ML	Aluminum 4 x 5 Rectangle Outlet	*	0.019	50	
	AORO238ML	Aluminum 2-3/8" Round Outlet	*	0.019	250	
	AORO234ML	Aluminum 2-3/4" Round Narrow Flange Outlet	*	0.019	250	
	AORO338ML	Aluminum 3-3/8" Round Outlet	*	0.019	100	
	AOOV23ML	Aluminum 2 x 3 Oval Outlet	*	0.019	30	
	AOOV34ML	Aluminum 3 x 4 Oval Outlet	*	0.019	50	
	AOOVN34ML	Aluminum 3 x 4 Oval Narrow Flange Outlet	*	0.019	50	
Oval Outlet 	GOOV3ML	Galvanized 3" Oval Drop Outlet	Mill	28 ga	50	
	GOOV4ML	Galvanized 4" Oval Drop Outlet	Mill	28 ga	50	
	CORE23	Copper 2 x 3 Rectangle Outlet	Copper	16 oz	Order by the pc.	
	CORE34	Copper 3 x 4 Rectangle Outlet	Copper	16 oz	Order by the pc.	

**\*NOTE:** Aluminum outlets made with mill or painted finish per manufacturer's discretion.

Wire Strainers		Part #	Description	Colors	Pieces/ Box
	GWS3	Galvanized 3" Wire Strainer	Mill	50	
	GWS4	Galvanized 4" Wire Strainer	Mill	50	

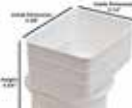
Drain Tile Adapters		Part #	Description	Colors	Pieces/ Box
APVC234 	DTA344 	APVC233WH	PVC 2 x 3 x 3 Flush Mount Adapter	WH	36
		APVC234WH	PVC 2 x 3 x 4 Flush Mount Adapter	WH	22
		APVC344WH	PVC 3 x 4 x 4 Flush Mount Adapter	WH	24
	DTA234 - -	High Density Polyethylene 2x3 Adapter	BK, WH	12	
	DTA344 - -	High Density Polyethylene 3x4 Adapter	BK, WH	24	

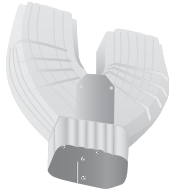
Y Adapters		Part #	Description	Colors	Nom. Gauge/ Thickness	Pieces/ Box
	AYA23 - -	Aluminum 2 x 3 Y Adapter	RB, WH	0.019	10	
	AYA34 - -	Aluminum 3 x 4 Y Adapter	RB, WH	0.019	10	

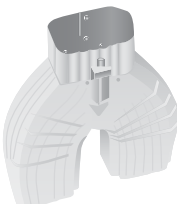
Y Diverters		Part #	Description	Colors	Nom. Gauge/ Thickness	Pieces/ Box
	AYD23 - -	Aluminum 2 x 3 Y Diverter	RB, WH	0.019	10	
	AYD34 - -	Aluminum 3 x 4 Y Diverter	RB, WH	0.019	10	

**Rainware Aluminum Colors:**

COLOR	CODE	COLOR	CODE	COLOR	CODE
BLACK	BK	ROYAL BROWN	RB	WHITE	WH



# NORANDEX™ Downspout Accessories

BELOIT PLANT

Funnels		Part #	Description	Colors	Nom. Gauge/ Thickness	Pieces/ Box
	AFN23 - -	Aluminum 2 x 3 Funnel	RB, WH	0.018	12	
	AFN34 - -	Aluminum 3 x 4 Funnel	RB, WH	0.018	12	

Downspout Bands		Part #	Description	Colors	Nom. Gauge/ Thickness	Pieces/ Box
	ADSPB34 - -	Alum. Universal 3 x 4 DS Band (Listed Below)	0.019	100		
	ADSPB34M2	Alum. Universal 3 x 4 DS Band M2 (Premium Color)	0.019	100		
	GDSPB23 - -	Galv. 2 x 3 Universal DS Band (Steel Colors)	28 ga	100		
	GDSPB34 - -	Galv. 3 x 4 Universal DS Band (Steel Colors)	28 ga	100		
	GDSPB34PR	Galv. 3 x 4 Universal DS Band	PR	28 ga	100	
	CDSPB34	Copper 3 x 4 DS Band	Copper	16 oz	Order by the pc.	

Downspout Clips		Part #	Description	Colors	Nom. Gauge/ Thickness	Pieces/ Box
	ADSCP23 - -	Aluminum 2 x 3 Clip	*(Listed Below)	0.032	100	
	ADSCP34 - -	Aluminum 3 x 4 Clip	(Listed Below)	0.032	50	
	ADSCP34M2	Aluminum 3 x 4 Clip	M2 (Premium Color)	0.032	50	
	CDSCP23	Copper 2 x 3 Clip	Copper	16 oz	Order by the pc.	

\*Rustic Copper temporarily unavailable in 2 x 3 size DS clip.

Downspout Cleats		Part #	Description	Colors	Nom. Gauge/ Thickness	Pieces/ Box
	APC1WH	Aluminum 2 x 3 Pipe Cleat	WH	0.019	100	

Downspout Hinges		Part #	Description	Colors	Pairs/ Bag	Bags/ Box	Pieces/ Box
	AZHHW	Aluminum 2 x 3 / 3 x 4 Zip Hinge	WH	12 pairs	20	240 pairs	
	GDHA23WH	Galvanized 2 x 3 A Hinge	WH			12	
	GDHA34WH	Galvanized 3 x 4 A Hinge	WH			12	
	GDHB23WH	Galvanized 2 x 3 B Hinge	WH			12	
	GDHB34WH	Galvanized 3 x 4 B Hinge	WH			12	

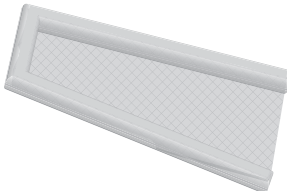
Splash Blocks		Part #	Description	Colors	Pieces/ Box
	SBGN	Splash Block - Green	GN	Order by the pc. 10 pcs./box	

## Rainware & Accessories Aluminum Colors | ● = Color-Thru System™

COLOR	CODE	COLOR	CODE	COLOR	CODE	COLOR	CODE	COLOR	CODE
● NX ALMOND	AD	● CLASSIC CREAM	CC	● NX GRANITE	GG	● REDWOOD	RW	● NX SIERRA CLAY	SI
● ALMOND	AL	● COPPER PENNY	CP	● HARBOR GREY	HG	● ROYAL BROWN	RB	● NX SILVER/SILVER GREY	SG
● BEAVER BROWN	BB	● COUNTRY BLUE	CU	● JEFFERSON TAN	JT	● NX RUSSET	RT	● NX TAN	TN
● BLACK	BK	● DESERT SAND	DS	● NX LINEN	LN	● RUSTIC COPPER	M2	● TERRA BRONZE	TB
● BRONZE	BZ	● EGG SHELL*	ES	● LINEN	LI	● *SAGE*	SA	● VICTORIAN GREY	VG
● BROOKSTONE	BS	● EVEREST	EV	● MONTANA SUEDE	MS	● NX SAND	SD	● VILLAGE GREEN	VI
● BUCKSKIN	BU	● EVERGREEN	EG	● MUSKET BROWN	MB	● NX SAND STONE	SS	● WICKER	WI
● CAMEO	CA	● FROST	FR	● NORWEGIAN WOOD	NW	● SANDTONE	ST	● 30 WHITE	WH
● NX CHAMPAGNE	CH			● PEBBLESTONE CLAY	PC			● 80 WHITE	80
● CHARCOAL GREY	CG								

\*Rustic Copper is a PREMIUM color. NOTE: Rustic Copper (M2) accessories, including miters and end caps, may display paint finish variations due to the metallic painting process, which may affect matching components.



## Extreme™ Miters



Extreme™ Miter

Part #	Description	Colors	Nom. Gauge/ Thickness	Pieces/ Box
AEM5 - -	Aluminum 5" Extreme™ Miter	RB, WH, 80	0.019	10
AEM6WH	Aluminum 6" Extreme™ Miter	WH	0.019	10

## Box Miters



Box Miter Inside

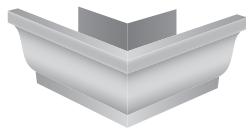

Box Miter Outside

Part #	Description	Colors	Nom. Gauge/ Thickness	Pieces/ Box
ABM5I - -	Aluminum 5" Inside	(Listed Below)	0.019	20
ABM5IM2	Aluminum 5" Inside	M2 (Premium Color)	0.019	20
ABM5O - -	Aluminum 5" Outside	(Listed Below)	0.019	20
ABM5OM2	Aluminum 5" Outside	M2 (Premium Color)	0.019	20
ABM6I - -	Aluminum 6" Inside	(Listed Below)	0.019	20
ABM6IM2	Aluminum 6" Inside	M2 (Premium Color)	0.019	20
ABM6O - -	Aluminum 6" Outside	(Listed Below)	0.019	20
ABM6OM2	Aluminum 6" Outside	M2 (Premium Color)	0.019	20
GBM5I - -	Galvanized 5" Inside	(Steel Colors)	28 ga	20
GBM5IPR	Galvanized 5" Inside	Prime	28 ga	20
GBM5O - -	Galvanized 5" Outside	(Steel Colors)	28 ga	20
GBM5OPR	Galvanized 5" Outside	Prime	28 ga	20
GBM6I - -	Galvanized 6" Inside	RB, WH	28 ga	20
GBM6IPR	Galvanized 6" Inside	Prime	28 ga	20
GBM6O - -	Galvanized 6" Outside	RB, WH	28 ga	20
GBM6OPR	Galvanized 6" Outside	Prime	28 ga	20
LBM6I	Galvalume 6" Inside	Mill	26 ga	20
LBM6O	Galvalume 6" Outside	Mill	26 ga	20
CBM5I	Copper 5" Inside	Copper	16 oz	Order by the pc.
CBM5O	Copper 5" Outside	Copper	16 oz	Order by the pc.
CBM6I	Copper 6" Inside	Copper	16 oz	Order by the pc.
CBM6O	Copper 6" Outside	Copper	16 oz	Order by the pc.

## Bay Miters



Bay Miters  
45° Inside



Bay Miters  
45° Outside

Part #	Description	Colors	Nom. Gauge/ Thickness	Pieces/ Box
ABY5I - -	Aluminum 5" Inside	(Listed Below)	0.019	20
ABY5IM2	Aluminum 5" Inside	M2 (Premium Color)	0.019	20
ABY5O - -	Aluminum 5" Outside	(Listed Below)	0.019	20
ABY5OM2	Aluminum 5" Outside	M2 (Premium Color)	0.019	20
ABY6I - -	Aluminum 6" Inside	(Listed Below)	0.019	20
ABY6IM2	Aluminum 6" Inside	M2 (Premium Color)	0.019	20
ABY6O - -	Aluminum 6" Outside	(Listed Below)	0.019	20
ABY6OM2	Aluminum 6" Outside	M2 (Premium Color)	0.019	20
ABY7I - -	Aluminum 7" Outside	BZ, CC, RB, ST, WH, 80	0.027	20
ABY7O - -	Aluminum 7" Outside	BZ, CC, RB, ST, WH, 80	0.027	20
LBY5I	Galvalume 5" Inside	Mill	26 ga	20
LBY5O	Galvalume 5" Outside	Mill	26 ga	20
LBY6I	Galvalume 6" Inside	Mill	26 ga	20
LBY6O	Galvalume 6" Outside	Mill	26 ga	20
CBY5I	Copper 5" Inside	Copper	16 oz	Order by the pc.
CBY5O	Copper 5" Outside	Copper	16 oz	Order by the pc.
CBY6I	Copper 6" Inside	Copper	16 oz	Order by the pc.
CBY6O	Copper 6" Outside	Copper	16 oz	Order by the pc.

## Rainware & Accessories Aluminum Colors | ● = Color-Thru System™

COLOR	CODE	COLOR	CODE	COLOR	CODE	COLOR	CODE	COLOR	CODE
● NX ALMOND	AD	● CLASSIC CREAM	CC	● NX GRANITE	GG	● REDWOOD	RW	● NX SIERRA CLAY	SI
● ALMOND	AL	● COPPER PENNY	CP	● HARBOR GREY	HG	● ROYAL BROWN	RB	● NX SILVER/SILVER GREY	SG
● BEAVER BROWN	BB	● COUNTRY BLUE	CU	● JEFFERSON TAN	JT	● NX RUSSET	RT	● NX TAN	TN
● BLACK	BK	● DESERT SAND	DS	● NX LINEN	LN	● RUSTIC COPPER	M2	● TERRA BRONZE	TB
● BRONZE	BZ	● EGG SHELL*	ES	● LINEN	LI	★ SAGE*	SA	● VICTORIAN GREY	VG
● BROOKSTONE	BS	● EVEREST	EV	● MONTANA SUEDE	MS	● NX SAND	SD	● VILLAGE GREEN	VI
● BUCKSKIN	BU	● EVERGREEN	EG	● MUSKET BROWN	MB	● NX SAND STONE	SS	● WICKER	WI
● CAMEO	CA	● FROST	FR	● NORWEGIAN WOOD	NW	● SANDTONE	ST	● 30 WHITE	WH
● NX CHAMPAGNE	CH			● PEBBLESTONE CLAY	PC			● 80 WHITE	80
● CHARCOAL GREY	CG								

\*Rustic Copper is a PREMIUM color. NOTE: Rustic Copper (M2) accessories, including miters and end caps, may display paint finish variations due to the metallic painting process, which may affect matching components.



# NORANDEX™ Strip Miters & Joints

BELOIT PLANT

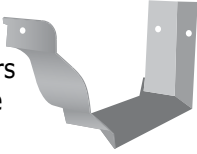
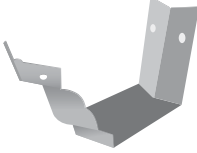
Strip Miters		Part #	Description	Colors	Nom. Gauge/ Thickness	Pieces/ Box
 Strip Miters 90° Inside	ASM5I - -	Aluminum 5" Inside	(Listed Below)	0.027	20	
	ASM5IM2	Aluminum 5" Inside	M2 (Premium Color)	0.027	20	
	ASM5O - -	Aluminum 5" Outside	(Listed Below)	0.027	20	
	ASM5OM2	Aluminum 5" Outside	M2 (Premium Color)	0.027	20	
	ASM6I - -	Aluminum 6" Inside	(Listed Below)	0.027	20	
	ASM6IM2	Aluminum 6" Inside	M2 (Premium Color)	0.027	20	
 Strip Miters 90° Outside	ASM6O - -	Aluminum 6" Outside	(Listed Below)	0.027	20	
	ASM6OM2	Aluminum 6" Outside	M2 (Premium Color)	0.027	20	
	ASM7I - -	Aluminum 7" Inside	BZ, CC, RB, ST, WH, 80	0.027	20	
	ASM7O - -	Aluminum 7" Outside	BZ, CC, RB, ST, WH, 80	0.027	20	
	LSM5I	Galvalume 5" Inside	Mill	26 ga	20	
	LSM5O	Galvalume 5" Outside	Mill	26 ga	20	
LSM6I	Galvalume 6" Inside	Mill	26 ga	20		
LSM6O	Galvalume 6" Outside	Mill	26 ga	20		
CSM5I	Copper 5" Inside	Copper	16 oz	Order by the pc.		
CSM5O	Copper 5" Outside	Copper	16 oz	Order by the pc.		
CSM6I	Copper 6" Inside	Copper	16 oz	Order by the pc.		
CSM6O	Copper 6" Outside	Copper	16 oz	Order by the pc.		

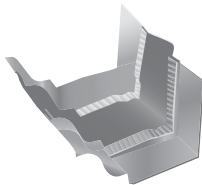
Expansion Joints		Part #	Description	Colors	Nom. Gauge/ Thickness	Pieces/ Box
	AEJ5ML	Aluminum 5" Expansion Joint	Mill	0.030	12	
	AEJ6ML	Aluminum 6" Expansion Joint	Mill	0.030	12	

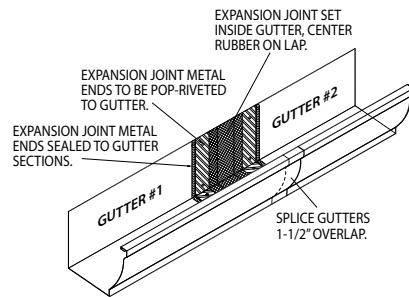

A 50' section of gutter can potentially expand almost 2/3 of an inch from winter to summer causing gutters to buckle. Expansion joints are a preventive measure for excessive movement in the gutter, and should be mounted in place every 50' of exceptionally long gutter runs.

Slip Joints		Part #	Description	Colors	Nom. Gauge/ Thickness	Pieces/ Box
	ASJC5 - -	Aluminum 5" Slip Joint	RB, WH	0.019	Order by the pc.	

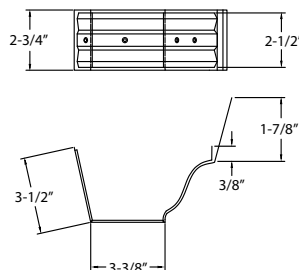

## Rainware & Accessories Aluminum Colors | ● = Color-Thru System™

COLOR	CODE	COLOR	CODE	COLOR	CODE	COLOR	CODE	COLOR	CODE
● NX ALMOND	AD	● CLASSIC CREAM	CC	● NX GRANITE	GG	● REDWOOD	RW	● NX SIERRA CLAY	SI
● ALMOND	AL	● COPPER PENNY	CP	● HARBOR GREY	HG	● ROYAL BROWN	RB	● NX SILVER/SILVER GREY	SG
● BEAVER BROWN	BB	● COUNTRY BLUE	CU	● JEFFERSON TAN	JT	● NX RUSSET	RT	● NX TAN	TN
● BLACK	BK	● DESERT SAND	DS	● NX LINEN	LN	● RUSTIC COPPER	M2	● TERRA BRONZE	TB
● BRONZE	BZ	● EGG SHELL*	ES	● LINEN	LI	● *SAGE*	SA	● VICTORIAN GREY	VG
● BROOKSTONE	BS	● EVEREST	EV	● MONTANA SUEDE	MS	● NX SAND	SD	● VILLAGE GREEN	VI
● BUCKSKIN	BU	● EVERGREEN	EG	● MUSKET BROWN	MB	● NX SAND STONE	SS	● WICKER	WI
● CAMEO	CA	● FROST	FR	● NORWEGIAN WOOD	NW	● SANDTONE	ST	● 30 WHITE	WH
● NX CHAMPAGNE	CH			● PEBBLESTONE CLAY	PC			● 80 WHITE	80
● CHARCOAL GREY	CG								

\*Rustic Copper is a PREMIUM color. NOTE: Rustic Copper (M2) accessories, including miters and end caps, may display paint finish variations due to the metallic painting process, which may affect matching components.



# NORANDEX™ End Caps

BELOIT PLANT

End Caps	Part #	Description	Colors	Nom. Gauge/ Thickness	Piece Length	Pieces/ Box
Right End Cap	AEC5L - -	Aluminum 5" Left End Cap - K-Style	(Listed Below)	0.019	5"	50
	AEC5LM2	Aluminum 5" Left End Cap - K-Style	M2 (Premium Color)	0.019	5"	50
Left End Cap	AEC5R - -	Aluminum 5" Right End Cap - K-Style	(Listed Below)	0.019	5"	50
	AEC5RM2	Aluminum 5" Right End Cap - K-Style	M2 (Premium Color)	0.019	5"	50
	AEC6L - -	Aluminum 6" Left End Cap - K-Style	(Listed Below)	0.019	6"	50
	AEC6LM2	Aluminum 6" Left End Cap - K-Style	M2 (Premium Color)	0.019	6"	50
	AEC6R - -	Aluminum 6" Right End Cap - K-Style	(Listed Below)	0.019	6"	50
	AEC6RM2	Aluminum 6" Right End Cap - K-Style	M2 (Premium Color)	0.019	6"	50
	AEC7L - -	Aluminum 7" Left End Cap - K-Style	BZ, CC, RB, ST, WH, 80	0.027	7"	25
	AEC7R - -	Aluminum 7" Right End Cap - K-Style	BZ, CC, RB, ST, WH, 80	0.027	7"	25
	GEC5L - -	Galv. 5" Left End Cap - K-Style	BB, BK, BZ, CC, CG, CU, DS, EG, HG, MB, PC, PR, RW, RB, TA, VG, WI, WH	28 ga	5"	50
	GEC5LPR	Galv. 5" Left End Cap - K-Style	Prime	28 ga	5"	50
	GEC5R - -	Galv. 5" Right End Cap - K-Style	BB, BK, BZ, CC, CG, CU, DS, EG, HG, MB, PC, PR, RW, RB, TA, VG, WI, WH	28 ga	5"	50
	GEC5RPR	Galv. 5" Right End Cap - K-Style	Prime	28 ga	5"	50
	GEC5ML	Galvanized 5" Left End Cap - K-Style	Mill	28 ga	5"	50
	GEC5RML	Galvanized 5" Right End Cap - K-Style	Mill	28 ga	5"	50
	GEC6L - -	Galvanized 6" Left End Cap - K-Style	(Steel Colors)	28 ga	6"	50
	GEC6LPR	Galvanized 6" Left End Cap - K-Style	Prime	28 ga	6"	50
	GEC6R - -	Galvanized 6" Right End Cap - K-Style	(Steel Colors)	28 ga	6"	50
	GEC6RPR	Galvanized 6" Right End Cap - K-Style	Prime	28 ga	6"	50
	LEC5L	Galvalume 5" Left End Cap - K-Style	Mill	26 ga	5"	50
	LEC5R	Galvalume 5" Right End Cap - K-Style	Mill	26 ga	5"	50
	LEC6L	Galvalume 6" Left End Cap - K-Style	Mill	26 ga	6"	50
	LEC6R	Galvalume 6" Right End Cap - K-Style	Mill	26 ga	6"	50
	CEC5L	Copper 5" Left End Cap - K-Style	Copper	16 oz	5"	Order by the pc.
	CEC5R	Copper 5" Right End Cap - K-Style	Copper	16 oz	5"	Order by the pc.
	CEC6L	Copper 6" Left End Cap - K-Style	Copper	16 oz	6"	Order by the pc.
	CEC6R	Copper 6" Right End Cap - K-Style	Copper	16 oz	6"	Order by the pc.

## Rainware & Accessories Aluminum Colors | ●=Color-Thru System™

COLOR	CODE	COLOR	CODE	COLOR	CODE	COLOR	CODE	COLOR	CODE
● NX ALMOND	AD	● CLASSIC CREAM	CC	● NX GRANITE	GG	● REDWOOD	RW	● NX SIERRA CLAY	SI
● ALMOND	AL	● COPPER PENNY	CP	● HARBOR GREY	HG	● ROYAL BROWN	RB	● NX SILVER/SILVER GREY	SG
● BEAVER BROWN	BB	● COUNTRY BLUE	CU	● JEFFERSON TAN	JT	● NX RUSSET	RT	● NX TAN	TN
● BLACK	BK	● DESERT SAND	DS	● NX LINEN	LN	● RUSTIC COPPER	M2	● TERRA BRONZE	TB
● BRONZE	BZ	● EGG SHELL*	ES	● LINEN	LI	★ SAGE*	SA	● VICTORIAN GREY	VG
● BROOKSTONE	BS	● EVEREST	EV	● MONTANA SUEDE	MS	● NX SAND	SD	● VILLAGE GREEN	VI
● BUCKSKIN	BU	● EVERGREEN	EG	● MUSKET BROWN	MB	● NX SAND STONE	SS	● WICKER	WI
● CAMEO	CA	● FROST	FR	● NORWEGIAN WOOD	NW	● SANDTONE	ST	● 30 WHITE	WH
● NX CHAMPAGNE	CH			● PEBBLESTONE CLAY	PC			● 80 WHITE	80
● CHARCOAL GREY	CG								

\*Rustic Copper is a PREMIUM color. NOTE: Rustic Copper (M2) accessories, including miters and end caps, may display paint finish variations due to the metallic painting process, which may affect matching components.

## Rainware Steel Colors:

COLOR	CODE	COLOR	CODE	COLOR	CODE	COLOR	CODE	COLOR	CODE
BEAVER BROWN	BB	CLASSIC CREAM	CC	HARBOR GREY	HG	REDWOOD	RW	WICKER	WI
BLACK	BK	COUNTRY BLUE	CU	MUSKET BROWN	MB	ROYAL BROWN	RB	30 WHITE	WH
BRONZE	BZ	DESERT SAND	DS	PEBBLESTONE CLAY	PC	TAHOE BLUE	TA	80 WHITE	80
CHARCOAL GREY	CG	EVERGREEN	EG	PRIME	PR	VICTORIAN GREY	VG		



# NORANDEX™ Hangers

BELOIT PLANT

## Hidden Hangers

Part #	Description	Colors	Nom. Gauge/ Thickness	Piece Length	Pieces/ Box or Bag
ABH5ML	Aluminum 5" Backless Std. Bar Hanger	Mill	0.060	5-1/16"	400
AHH5ML	Aluminum 5" Hook Hanger with Clip	Mill	0.060	4-7/8"	500
AHH51ML	Aluminum 5" Hook Hanger with Clip	Mill	0.060	4-7/8"	100
AHT5ML	Aluminum 5" Hangtite Hanger without Clip	Mill	0.060	5"	1000
AHT51ML	Aluminum 5" Hangtite Hanger without Clip	Mill	0.060	5"	100
AHT5CML	Aluminum 5" Hangtite Hanger with Clip	Mill	0.060	5"	1000
AHU51ML	Aluminum 5" Ultra Hanger without Clip	Mill	0.048	5"	100
AHU5ML	Aluminum 5" Ultra Hanger without Clip	Mill	0.048	5"	1000
AHU51CML	Aluminum 5" Ultra Hanger with Clip	Mill	0.048	5"	100
AHU5CML	Aluminum 5" Ultra Hanger with Clip	Mill	0.048	5"	1000
ABH6ML	Aluminum 6" Backless Std. Bar Hanger	Mill	0.060	6-1/8"	750
AHH6ML	Aluminum 6" Hook Hanger with Clip	Mill	0.060	6"	250
AHHK6ML	Aluminum 6" Keg Hanger with Clip	Mill	0.060	6"	2500
AHT6ML	Aluminum 6" Hangtite Hanger without Clip	Mill	0.060	6"	1000
AHT6CML	Aluminum 6" Hangtite Hanger with Clip	Mill	0.060	6"	1000
AHU61ML	Aluminum 6" Ultra Hanger without Clip	Mill	0.048	6"	100
AHU6ML	Aluminum 6" Ultra Hanger without Clip	Mill	0.048	6"	1000
AHU61CML	Aluminum 6" Ultra Hanger with Clip	Mill	0.048	6"	100
AHU6CML	Aluminum 6" Ultra Hanger with Clip	Mill	0.048	6"	800
BH5	Brass 5" Hanger with Clip	Brass	0.115	5-1/8"	250
BH6	Brass 6" Hanger with Clip	Brass	0.115	6-3/16"	150
CH5	Copper 5" Hook Hanger	Copper	16 oz	5"	Order by the pc.
CH6	Copper 6" Hook Hanger	Copper	16 oz	6"	Order by the pc.

ABH5ML



AHH5ML



AHT5CML



BH5



CH5



ABH5ML

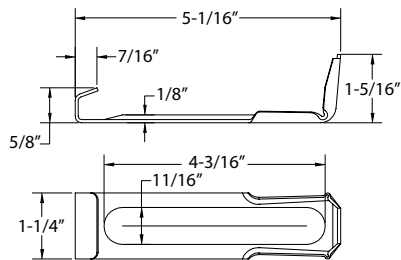

AHH5, AHH51

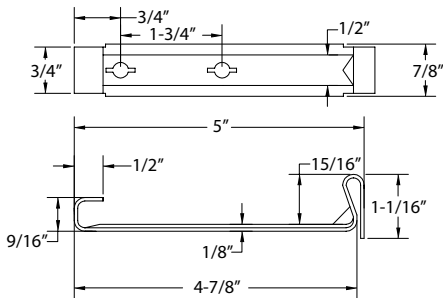

BH5

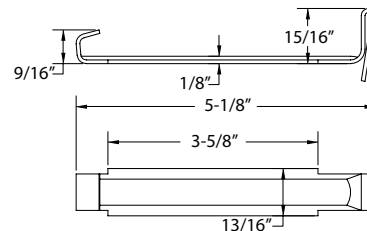

ABH6ML

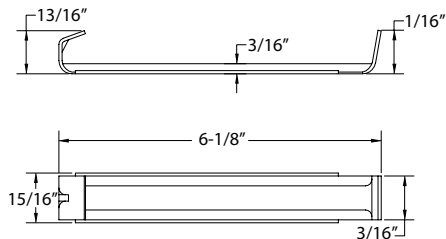

BH6

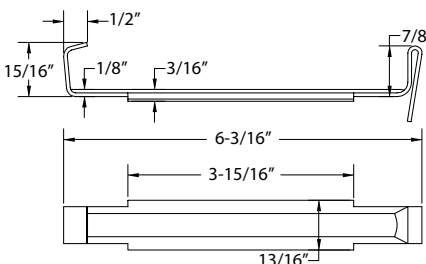



# NORANDEX™ Hangers

BELOIT PLANT

## Wrap Around Hangers

Part #	Description	Colors	Nom. Gauge/ Thickness	Piece Length	Pieces/ Box
AWAH5 - -	Aluminum 5" Wrap Around Hanger	RB, WH, 80	0.060	16-3/4"	100
AWAH6 - -	Aluminum 6" Wrap Around Hanger	RB, WH, 80	0.060	20-1/4"	50

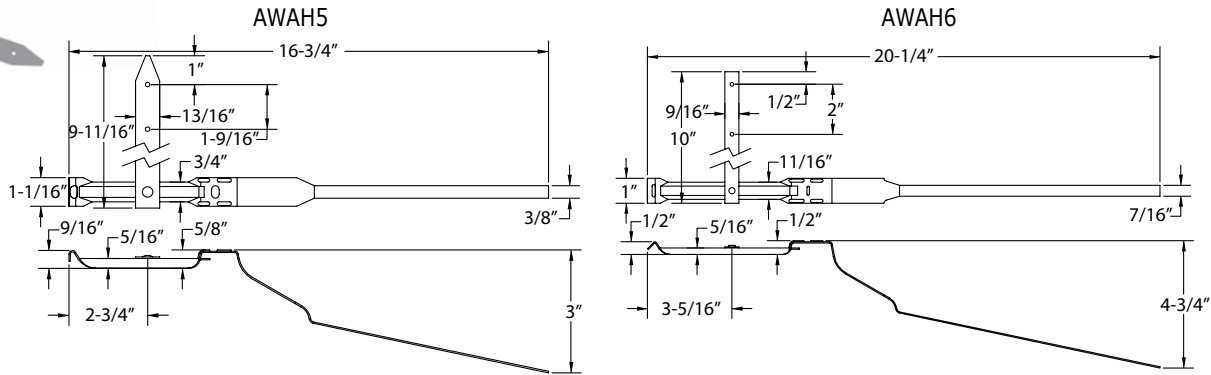
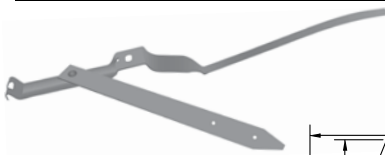

## T-Bar Hangers

Part #	Description	Colors	Nom. Gauge/ Thickness	Piece Length	Pieces/ Bag	Pieces/ Box
ATBH5 - -	Alum. 5" Painted T-Bar Strap Hanger	RB, WH	0.060	12-1/2"		100
ATBH5ML	Alum. 5" Painted T-Bar Strap Hanger	Mill	0.060	12-1/2"		100
ATBH6 - -	Alum. 6" Painted T-Bar Strap Hanger	WH	0.060	6-1/8"		100
ATBH6ML	Alum. 6" Painted T-Bar Strap Hanger	Mill	0.060	6-1/8"		100
ATS5ML	Alum. 5/8" T-Bar Strap only	Mill	0.032	9-7/8"	100	2000

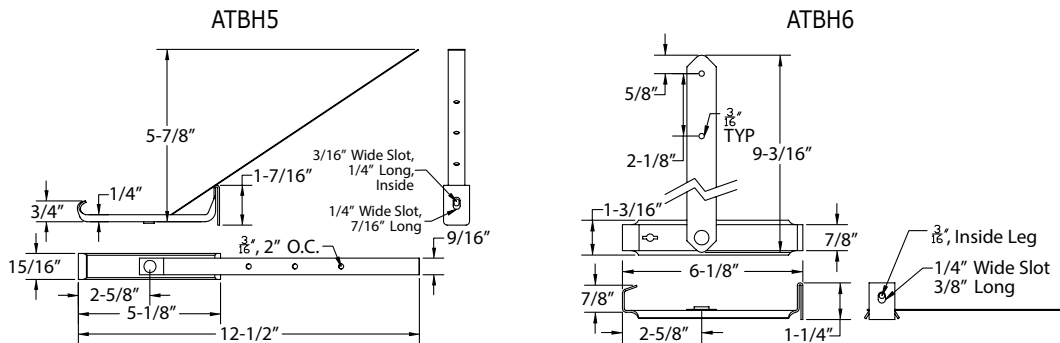

## Vampire Hangers

Part #	Description	Colors	Nom. Gauge/ Thickness	Piece Length	Pieces/ Box
AVH5ML	Aluminum 5" Vampire Hanger	Mill	0.060	5-1/2"	100
AVH6ML	Aluminum 6" Vampire Hanger	Mill	0.060	6-9/16"	100



**Note:** Proper installation requires the use of a Vampire Hanger tool manufactured by "Malco".

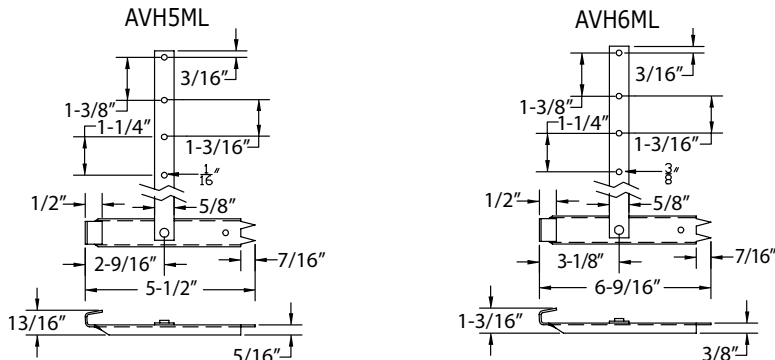

## Rainware Aluminum Colors:

COLOR	CODE	COLOR	CODE	COLOR	CODE
ROYAL BROWN	RB	WHITE	WH	80 WHITE	80



# NORANDEX™ Hangers & Rainware Accessories BELOIT PLANT

## T-Wedge

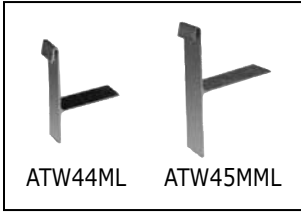

Part #	Description	Colors	Nom. Gauge/ Thickness	Pieces/ Bag
ATW44ML	Aluminum 5" T-Wedge 4400	Mill	0.070	50
ATW45MML	Aluminum 5"-6" T-Wedge 4500	Mill	0.070	50

A T-Wedge can be adjusted to keep the gutter level at various fascia board angles.

## Gutter Wedges

GW5, GW6

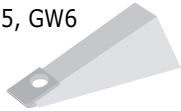

Part #	Description	Colors	Nom. Gauge/ Thickness	Pieces/ Box
GW5 - -	Aluminum 5" Wedge	RB, WH	0.027	100
GW6 - -	Aluminum 6" Wedge	RB, WH	0.027	50
CW5	Copper 5" Wedge	Copper	16 oz	Order by the pc.
CW6	Copper 6" Wedge	Copper	16 oz	Order by the pc.

## Hangers with Screws

AHFHS5ML, GHFHS5ML



GHH5ML



Part #	Description	Colors	Nom. Gauge/ Thickness	Piece Length	Pieces/ Box	Pieces/ Pallet
AHFHS5ML	Alum. 5" Quick Screw Hidden Hanger w/Screw	Mill	0.060	5"	500	
AHFHS6ML	Alum. 6" Quick Screw Hidden Hanger w/Screw	Mill	0.060	6"	300	
AHFSS5ML	Alum. 5" Supreme Hanger w/Screw	Mill	0.060	5"	400	
AHFSS6ML	Alum. 6" Supreme Hanger w/Screw	Mill	0.060	6"	300	
AHUTS5CML	Alum. 5" Ultimate Hidden Hanger w/Screw & Clip	Mill	0.061	5"	400	
AHUTS6CML	Alum. 6" Ultimate Hidden Hanger w/Screw & Clip	Mill	0.061	6"	300	
AHFHS7ML	Alum. 7" Quick Screw Hidden Hanger w/Screw	Mill	0.060	7"	100	
GHFHS5ML	Galv. 5" Hang Fast w/Screw	Mill	18 ga	5"	250	
GHH5ML	Galv. 5" Hook Hanger w/Hole	Mill	18 ga	5"	250	26,250
GHH6ML	Galv. 6" Hook Hanger w/Hole	Mill	18 ga	6"	150	
BHFHS5	Brass 5" Hang Fast Hanger w/Screw	Brass	0.115	5"	Order by the pc.	
BHFHS6	Brass 6" Hang Fast Hanger w/Screw	Brass	0.115	6"	Order by the pc.	

GHH5ML

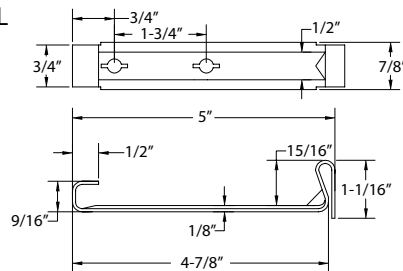

## Spikes



Part #	Description	Colors	Piece Length	Pieces/ Box
AS7WH	Aluminum 7" Painted Spike	WH	7"	500
AS7ML	Aluminum 7" Painted Spike	Mill	7"	500
AS8WH	Aluminum 8" Painted Spike	WH	8"	500
AS8ML	Aluminum 8" Painted Spike	Mill	8"	500
GS7ML	Galvanized 7" Ring Shank	Mill	7"	Approx 800 ct./50 lbs.

## Rainware Aluminum Colors:

COLOR	CODE	COLOR	CODE
ROYAL BROWN	RB	WHITE	WH



# NORANDEX™ Rainware Accessories

BELOIT PLANT

## Ferrules



Part #	Description	Colors	Piece Length	Pieces/Box
AF5ML	Aluminum 5" Ferrule	Mill	5"	500
AF6ML	Aluminum 6" Ferrule	Mill	6"	500

## Fascia Brackets

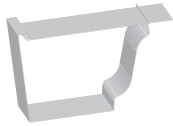

Part #	Description	Colors	Nom. Gauge/Thickness	Pieces/Box
AFBH5WH	Aluminum 5" Fascia Bracket	WH	0.060	100

## Drive Pins



Part #	Description	Colors	Piece Length	Pieces/Box
GDP34	Galvanized 3/4" Masonry Fastener	Mill	3/4"	100
GDP10	Galvanized 1" Masonry Fastener	Mill	1"	100
GDP125	Galvanized 1-1/4" Masonry Fastener	Mill	1-1/4"	100
GDP150	Galvanized 1-1/2" Masonry Fastener	Mill	1-1/2"	100

### Rainware Aluminum Colors:

COLOR	CODE	COLOR	CODE
WHITE	WH	80 WHITE	80



# NORANDEX™ Round & Half Round Products

BELOIT PLANT

## Half Round Gutters

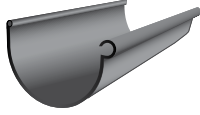

Part #	Description	Colors	Nom. Gauge/ Thickness	Piece Length	Pieces/ Box	Boxes/ Pallet
AGUH610 - -	Alum. 6" Reverse Bead 10' Sections	(Listed Below)	0.027	10'	5	16
AGUH610M2	Alum. 6" Reverse Bead 10' Sections	M2 (Premium Color)	0.027	10'	5	16
AGUH620 - -	Alum. 6" Reverse Bead 20' Sections	(Listed Below)	0.027	20'	5	16
AGUH620M2	Alum. 6" Reverse Bead 20' Sections	M2 (Premium Color)	0.027	20'	5	16
LGUH610	Glum. 6" Reverse Bead 10' Sections	Mill	26 ga	10'	5	16
LGUH620	Glum. 6" Reverse Bead 20' Sections	Mill	26 ga	20'	5	16
CGUH610	Copper 6" Reverse Bead 10' Sections	Copper	16 oz	10'	5	
CGUH620	Copper 6" Reverse Bead 20' Sections	Copper	16 oz	20'	5	

**Sold in 5-count cartons only.**

## Round Downspouts



Part #	Description	Colors	Nom. Gauge/ Thickness	Piece Length	Pieces/ Box	Boxes/ Pallet
ADSR310 - -	Alum. 3" Round x 10', Smooth	(Listed Below)	0.019	10'	5	30
ADSR310M2	Alum. 3" Round x 10', Smooth	M2 (Premium Color)	0.019	10'	5	30
ADSR410 - -	Alum. 4" Round x 10', Smooth	(Listed Below)	0.019	10'	5	20
ADSR410M2	Alum. 4" Round x 10', Smooth	M2 (Premium Color)	0.019	10'	5	20
GDSR410 - -	Galv. 4" Round x 10'	(Listed Below)	26 ga	10'	5	30
GDSR410ML	Galv. 4" Round x 10'	Mill	26 ga	10'	5	30
LDSR310	Glum. 3" Round x 10', Plain	Mill	26 ga	10'	5	28
LDSR410	Glum. 4" Round x 10', Plain	Mill	26 ga	10'	5	28
CDSR310	Copper 3" Round x 10', Smooth	Copper	16 oz	10'	Order by the pc.	
CDSR410	Copper 4" Round x 10', Smooth	Copper	16 oz	10'	Order by the pc.	

## Rainware & Accessories Aluminum Colors

COLOR	CODE	COLOR	CODE	COLOR	CODE	COLOR	CODE	COLOR	CODE
ALMOND	AL	CAMEO	CA	■ MUSKET BROWN	MB	★ ■ RUSTIC COPPER	M2	VICTORIAN GREY	VG
BEAVER BROWN	BB	CHARCOAL GREY	CG	NX LINEN	LN	SANDTONE	ST	WICKER	WI
BLACK	BK	CLASSIC CREAM	CC	PEBBLESTONE CLAY	PC	NX SIERRA CLAY	SI	■ 30 WHITE	WH
■ BRONZE	BZ	■ COPPER PENNY	CP	ROYAL BROWN	RB	TERRA BRONZE	TB	80 WHITE	80
BUCKSKIN	BU	HARBOR GREY	HG						

■ Stocked half-round colors. Balance of colors available with extended lead-time.

★ Rustic Copper is a PREMIUM color. NOTE: Rustic Copper (M2) accessories, including miters and end caps, may display paint finish variations due to the metallic painting process, which may affect matching components.

## Rainware Steel Colors:

COLOR	CODE	COLOR	CODE	COLOR	CODE	COLOR	CODE	COLOR	CODE
BEAVER BROWN	BB	CLASSIC CREAM	CC	EVERGREEN	EG	PEBBLESTONE CLAY	PC	TAHOE BLUE	TA
BLACK	BK	COUNTRY BLUE	CU	HARBOR GREY	HG	PRIME	PR	VICTORIAN GREY	VG
BRONZE	BZ	DESERT SAND	DS	HARVEST BROWN	HV	REDWOOD	RW	WICKER	WI
CHARCOAL GREY	CG	EGGSHELL	ES	MUSKET BROWN	MB	ROYAL BROWN	RB	30 WHITE	WH





# NORANDEX™ Round Products

BELOIT PLANT

## Round Elbows

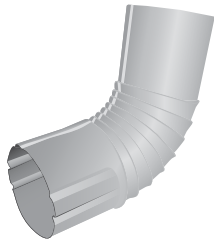

Part #	Description	Colors	Nom. Gauge/ Thickness	Pieces/ Box	Boxes/ Pallet
AER3 - -	Aluminum 3" Round 75°	(Listed Below)	0.019	30	16
AER3M2	Aluminum 3" Round 75°	M2 (Premium Color)	0.019	30	16
AER390 - -	Aluminum 3" Round 90°	(Listed Below)	0.019	25	16
AER390M2	Aluminum 3" Round 90°	M2 (Premium Color)	0.019	25	16
AER4 - -	Aluminum 4" Round 75°	(Listed Below)	0.019	30	16
AER4M2	Aluminum 4" Round 75°	M2 (Premium Color)	0.019	30	16
GER430ML	Galvanized 4" Round 30°	Mill	26 ga	20	24
GER445 - -	Galvanized 4" Round 45°	(Listed Below)	26 ga	20	24
GER445ML	Galvanized 4" Round 45°	Mill	26 ga	20	24
GER475 - -	Galvanized 4" Round 75°	(Listed Below)	26 ga	20	24
GER475ML	Galvanized 4" Round 75°	Mill	26 ga	20	24
LER3	Galvalume 3" Round 75°	Mill	26 ga	10	32
LER445	Galvalume 4" Round 45°	Mill	26 ga	10	32
LER4	Galvalume 4" Round 75°	Mill	26 ga	10	32
CER330	Copper 3" Round 30°	Copper	16 oz	Order by the pc.	
CER3	Copper 3" Round 75°	Copper	16 oz	Order by the pc.	
CER430	Copper 4" Round 30°	Copper	16 oz	Order by the pc.	
CER4	Copper 4" Round 75°	Copper	16 oz	Order by the pc.	

## Round Offsets



Part #	Description	Colors	Nom. Gauge/ Thickness	Pieces/ Box
ABO12R3 - -	Aluminum 2" Offset 3" Round	(Listed Below)	0.019	20
ABO12R3M2	Aluminum 2" Offset 3" Round	M2 (Premium Color)	0.019	20
ABO14R3 - -	Aluminum 4" Offset 3" Round	(Listed Below)	0.019	20
ABO14R3M2	Aluminum 4" Offset 3" Round	M2 (Premium Color)	0.019	20
ABO12R4 - -	Aluminum 2" Offset 4" Round	(Listed Below)	0.019	20
ABO12R4M2	Aluminum 2" Offset 4" Round	M2 (Premium Color)	0.019	20
ABO14R4 - -	Aluminum 4" Offset 4" Round	(Listed Below)	0.019	20
ABO14R4M2	Aluminum 4" Offset 4" Round	M2 (Premium Color)	0.019	20
ABO16R4	Aluminum 6" Offset 4" Round	(Listed Below)	0.019	20
CBO12R3	Copper 2" Offset 3" Round	Copper	16 oz	Order by the pc.
CBO14R3	Copper 4" Offset 3" Round	Copper	16 oz	Order by the pc.
CBO12R4	Copper 2" Offset 4" Round	Copper	16 oz	Order by the pc.
CBO14R4	Copper 4" Offset 4" Round	Copper	16 oz	Order by the pc.
CBO16R4	Copper 6" Offset 4" Round	Copper	16 oz	Order by the pc.

## Rainware & Accessories Aluminum Colors

COLOR	CODE	COLOR	CODE	COLOR	CODE	*COLOR	CODE	COLOR	CODE
ALMOND	AL	CAMEO	CA	■ MUSKET BROWN	MB	■ RUSTIC COPPER	M2	VICTORIAN GREY	VG
BEAVER BROWN	BB	CHARCOAL GREY	CG	NX LINEN	LN	SANDTONE	ST	WICKER	WI
BLACK	BK	CLASSIC CREAM	CC	PEBBLESTONE CLAY	PC	NX SIERRA CLAY	SI	■ 30 WHITE	WH
■ BRONZE	BZ	■ COPPER PENNY	CP	ROYAL BROWN	RB	TERRA BRONZE	TB	80 WHITE	80
BUCKSKIN	BU	HARBOR GREY	HG						

■ Stocked half-round colors. Balance of colors available with extended lead-time.

\*Rustic Copper is a PREMIUM color. NOTE: Rustic Copper (M2) accessories, including miters and end caps, may display paint finish variations due to the metallic painting process, which may affect matching components.

## Rainware Steel Colors:

COLOR	CODE	COLOR	CODE	COLOR	CODE	COLOR	CODE	COLOR	CODE
BEAVER BROWN	BB	CLASSIC CREAM	CC	EVERGREEN	EG	PEBBLESTONE CLAY	PC	TAHOE BLUE	TA
BLACK	BK	COUNTRY BLUE	CU	HARBOR GREY	HG	PRIME	PR	VICTORIAN GREY	VG
BRONZE	BZ	DESERT SAND	DS	HARVEST BROWN	HV	REDWOOD	RW	WICKER	WI
CHARCOAL GREY	CG	EGGSHELL	ES	MUSKET BROWN	MB	ROYAL BROWN	RB	30 WHITE	WH



# NORANDEX™ Half Round Products

BELOIT PLANT

## Half Round Outlets



Part #	Description	Colors	Nom. Gauge/ Thickness	Pieces/ Box
AOROH63ML	Aluminum 3" Round x 6" HR Outlet	*	0.019	50
AOROH64ML	Aluminum 4" Round x 6" HR Outlet	*	0.019	50
GOROH63	Galvanized 3" Round x 6" HR Outlet	*	26 ga	Order by the pc.
GOROH64	Galvanized 4" Round x 6" HR Outlet	*	26 ga	Order by the pc.
COROH63	Copper 3" Round x 6" HR Outlet	Copper	16 oz	Order by the pc.
COROH64	Copper 4" Round x 6" HR Outlet	Copper	16 oz	Order by the pc.

**\*NOTE:** Aluminum outlets made with mill or painted finish per manufacturer's discretion.

## Half Round Miters

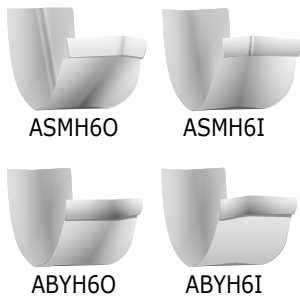

Part #	Description	Colors	Nom. Gauge/ Thickness	Pieces/ Box
ASM61 - -	Aluminum 6" 90°, Strip, Inside	(Listed Below)	0.027	20
ASM61M2	Aluminum 6" 90°, Strip, Inside	M2 (Premium Color)	0.027	20
ASM60 - -	Aluminum 6" 90°, Strip, Outside	(Listed Below)	0.027	20
ASM60M2	Aluminum 6" 90°, Strip, Outside	M2 (Premium Color)	0.027	20
ABYH61 - -	Aluminum 6" 45°, Bay, Inside	(Listed Below)	0.027	20
ABYH61M2	Aluminum 6" 45°, Bay, Inside	M2 (Premium Color)	0.027	20
ABYH60 - -	Aluminum 6" 45°, Bay, Outside	(Listed Below)	0.027	20
ABYH60M2	Aluminum 6" 45°, Bay, Outside	M2 (Premium Color)	0.027	20
LSM61	Galvalume 6" 90°, Strip, Inside	Mill	26 ga	20
LSM60	Galvalume 6" 90°, Strip, Outside	Mill	26 ga	20
CSM61	Copper 6" 90°, Strip, Inside	Copper	16 oz	20
CSM60	Copper 6" 90°, Strip, Outside	Copper	16 oz	20

## Half Round Slip Joints



Part #	Description	Colors	Nom. Gauge/ Thickness	Pieces/ Box
ASJCH6WH	Aluminum 6" HR Slip Joint	WH	0.019	Order by the pc.
LSJCH6WH	Galvalume 6" HR Slip Joint	WH	26 ga	Order by the pc.

## Half Round End Caps

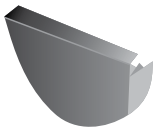

Part #	Description	Colors	Nom. Gauge/ Thickness	Pieces/ Box
AECH6 - -	Aluminum 6" HR Universal End Cap	(Listed Below)	0.019	20
AECH6M2	Aluminum 6" HR Universal End Cap	M2 (Premium Color)	0.019	20
LECH6	Galvalume 6" HR Universal End Cap	Mill	26 ga	20
CECH6	Copper 6" HR Universal End Cap	Copper	16 oz	20

## Rainware & Accessories Aluminum Colors

COLOR	CODE	COLOR	CODE	COLOR	CODE	COLOR	CODE	COLOR	CODE
ALMOND	AL	CAMEO	CA	■ MUSKET BROWN	MB	* ■ RUSTIC COPPER	M2	VICTORIAN GREY	VG
BEAVER BROWN	BB	CHARCOAL GREY	CG	NX LINEN	LN	SANDTONE	ST	WICKER	WI
BLACK	BK	CLASSIC CREAM	CC	PEBBLESTONE CLAY	PC	NX SIERRA CLAY	SI	■ 30 WHITE	WH
■ BRONZE	BZ	■ COPPER PENNY	CP	ROYAL BROWN	RB	TERRA BRONZE	TB	80 WHITE	80
BUCKSKIN	BU	HARBOR GREY	HG						



■ Stocked half-round colors. Balance of colors available with extended lead-time.



\*Rustic Copper is a PREMIUM color. NOTE: Rustic Copper (M2) accessories, including miters and end caps, may display paint finish variations due to the metallic painting process, which may affect matching components.

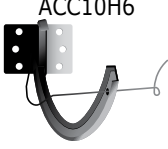

# NORANDEX™ Half Round Products

BELOIT PLANT

Half Round Brackets		Part #	Description	Colors	Pieces/Box
	ACC10H6	ACC10H6 - -	Aluminum 6" HR Combo Cir/Shk w/Clip Hanger	BZ, MB, 80	Order by the pc.
		ACC10H6ML	Aluminum 6" HR Combo Cir/Shk w/Clip Hanger	Mill	Order by the pc.
	AHRFH6	AHRFH6 - -	Aluminum 6" HR Fascia Hanger	BK, BZ, MB, WH	Order by the pc.
		GCC10H6	Galvanized 6" HR Combo Cir/Shk w/Clip Hanger	Mill	Order by the pc.
		LHRFH6	Galvalume 6" HR Fascia Hanger	Mill	Order by the pc.
		CCC10H6	Copper 6" HR Combo Cir/Shk w/Clip Hanger	Copper	Order by the pc.
		CHRFH6	Copper 6" HR Fascia Hanger	Copper	25

Half Round Hidden Hangers		Part #	Description	Colors	Pieces/Box
	AHHHR6ML	AHHHR6ML	Aluminum 6" HR Hook Hanger	Mill	100
		AHHSR6ML	Aluminum 6" HR Hidden Clip Hanger w/Screw	Mill	100
	AHHSR6ML	SHHHR6ML	Stainless Steel 6" HR Hook Hanger	Mill	100
			<b>Note: Only for reverse bead half round gutters</b>		

Half Round T-Wedge Hangers		Part #	Description	Colors	Nom. Gauge/Thickness	Pieces/Bag
	ATWHR49ML	ATWHR49ML	Aluminum HR T-Wedge 4900	Mill	0.070	50
			<i>A T-Wedge can be adjusted to keep the gutter level at various fascia board angles.</i>			

### Rainware Aluminum Colors:

COLOR	CODE	COLOR	CODE	COLOR	CODE	COLOR	CODE	COLOR	CODE
BLACK	BK	BRONZE	BZ	MUSKET BROWN	MB	WHITE	WH	80 WHITE	80



**Screen Systems**



**NX Premium Stainless Steel Micro Mesh**

*The ultimate in gutter protection! This tightly woven, heavy gauge stainless steel micro mesh gutter guard, with its corrosion-resistant properties, is a significant debris deterrent. It installs easily under the shingles and fastens to the front gutter hem with provided screws, while self-adjusting to various roof pitches.*

Part #	Description	Color	Nom. Gauge/ Thickness	Piece Length	Pieces/ Box	Feet/ Box
ALGP5SPML	5" Premium SS Micro Mesh	Mill	14 ga	4'	25	100'
ALGP6SPML	6" Premium SS Micro Mesh	Mill	14 ga	4'	25	100'
ALMMMI56ML	Stainless Steel Mesh Inside Corner 5/6"	Mill	14 ga	-	3	-



**NX Drop-In**

*The front attachment provides a firm hold to the front of the gutter and has a wide mounting flange for a permanent install. The mill finish aluminum screen is micro crimped for enhanced durability.*

ALGP5DIML	Aluminum 5" Drop-In	Mill	0.025	4'	50	200'
ALGP6DIML	Aluminum 6" Drop-In	Mill	0.025	4'	50	200'



**NX Lock Small Hole**

*The small hole screen system installs quickly without disturbing the shingles with its front and back snap lock system.*

GGP5LSHBK	Galvanized 5" Lock Small Hole	BK	28 ga	4'	25	100'
GGP6LSHBK	Galvanized 6" Lock Small Hole	BK	28 ga	4'	25	100'
GGP7LSHBK	Galvanized 7" Lock Small Hole	BK	28 ga	4'	25	100'



**NX Lock Regular Hole**

*The regular hole screen system installs quickly without disturbing the shingles with its front and back snap lock system.*

GGP5LRHBK	Galvanized 5" Lock Regular Hole	BK	28 ga	4'	25	100'
GGP6LRHBK	Galvanized 6" Lock Regular Hole	BK	28 ga	4'	25	100'



**NX Step Down**

*The small hole screen incorporates a raised snap-in system in the back of the gutter to seal off the void between the shingles and the screen. Step Down installs quickly without the use of screws or disturbing the shingles.*

GGP5SDBK	Galvanized 5" Step Down	BK	28 ga	4'	25	100'
GGP6SDBK	Galvanized 6" Step Down	BK	28 ga	4'	25	100'



**NX Premium Lock**

*The tiny holes keep out small debris, while allowing water to flow through the screen. Two stiffening beads run down the center of the screen for added strength. Installation is quick and easy without disturbing the shingles. The screen locks into place with a raised back and front-tiered mounting system.*

ALGP5PLBK	Aluminum 5" Premium Lock (screen tiny holes)	BK	0.032	4'	25	100'
ALGP6PLBK	Aluminum 6" Premium Lock (screen tiny holes)	BK	0.032	4'	25	100'



**NX Deluxe Half Round**

*Spring tension design holds this gutter screen in place. Snaps in and out of half round gutters for easy cleaning. 28 gauge steel stands tough under a full load of wet leaves without collapsing. Installs with a slope toward the front to help debris slide off.*

GLGEZ6DH	Galvanized 6.5" Deluxe Half Round	BK	28 ga	4'	25	100'
----------	-----------------------------------	----	-------	----	----	------

**Gutter Screen System Color:**

COLOR	CODE	COLOR	CODE
BLACK	BK	MILL	ML



# NORANDEX™ Gutter Protection

BELOIT PLANT

Perforated & Dome	Part #	Description	Colors	Nom. Gauge/ Thickness	Piece Length	Pieces/ Box	Feet/ Box
-------------------	--------	-------------	--------	--------------------------	-----------------	----------------	--------------



### NX Smooth Flow

The perforated cover installs easily without disturbing the shingles. Product is factory notched for easy overlapping. Dual center ribbed bends provide extra rigidity against expansion and contraction. Six 50-count bags of #6 hex head 3/8 stainless steel painted screws are included.

ALGP5SF - -	5" Smooth Flow	BK, WH	0.019	6'	40	240'
ALGP5SFML	5" Smooth Flow	Mill	0.019	6'	40	240'
ALGP510SF -	5" Smooth Flow	B, W	0.019	10'	25	250'
ALGP510SFM	5" Smooth Flow	Mill	0.019	10'	25	250'
ALGP6SF - -	6" Smooth Flow	BK, WH	0.019	6'	40	240'
ALGP6SFML	6" Smooth Flow	Mill	0.019	6'	40	240'
ALGP610SF -	6" Smooth Flow	B, W	0.019	10'	25	250'
ALGP610SFM	6" Smooth Flow	Mill	0.019	10'	25	250'



### NX Master Flow

The snap in perforated panels are installed without disturbing the shingles and without the use of screws. The patented curved back portion keeps the contoured front mounting system in place, provides a gentle transition of rainwater on to the panel, blocks debris from depositing in the back of the gutter, and is not obstructed by screw hangers.

ALGP5MFBK	Aluminum 5" Master Flow	BK	0.019	4'	25	100'
ALGP6MFBK	Aluminum 6" Master Flow	BK	0.019	4'	25	100'



### NX Snap-In Dome Cover

This unique solid dome cover is designed for maximum debris load and is one of the easiest dome cover systems to install. The dome cover snaps in without the use of brackets or screws and doesn't disturb the shingles. Snap-In Dome is available in several colors to enhance the curb appeal of your home by blending in with the roof line.

ALGP5SD - -	Aluminum 5" Snap-In Dome	BK, RB, TB, WH	0.028	4'	14	56'
ALGP6SD - -	Aluminum 6" Snap-In Dome	BK, RB, TB, WH	0.028	4'	14	56'



### NX Solid Cover

This solid guard allows the water to track around the front (by surface tension) and into the gutter, while forcing debris to fly off. It also features a perforated bend line where the metal meets the roof.

ALGEZ5SO - -	Aluminum 5" Solid	BK, RB, TB, WH	0.019	4'	25	100'
ALGEZ6SO - -	Aluminum 6" Solid	BK, RB, TB, WH	0.019	4'	25	100'



### NX Inside Miter Kit

A5SDIMK - -	Alum. 5" 1 Rt Panel, 1 Lft Panel & 4' Rain Diverter	BK, RB, TB, WH	0.027	4'	1 pair/box	
A6SDIMK - -	Alum. 6" 1 Rt Panel, 1 Lft Panel & 4' Rain Diverter	BK, RB, TB, WH	0.027	4'	1 pair/box	

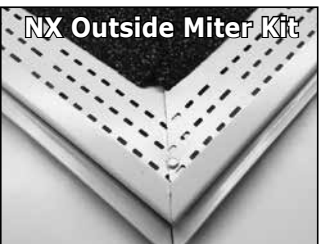

### NX Outside Miter Kit

A5SDOMK - -	Aluminum 5" 1 Right Panel & 1 Left Panel	BK, RB, TB, WH	0.027	4'	1 pair/box	
A6SDOMK - -	Aluminum 6" 1 Right Panel & 1 Left Panel	BK, RB, TB, WH	0.027	4'	1 pair/box	

### NX Universal End Caps

A5SDUEC - -	Aluminum 5" Universal End Caps	BK, RB, TB, WH	0.019		10/Bag	
A6SDUEC - -	Aluminum 6" Universal End Caps	BK, RB, TB, WH	0.019		10/Bag	



### Gutter Protection Colors:

COLOR	CODE	COLOR	CODE	COLOR	CODE	COLOR	CODE	COLOR	CODE
BLACK	BK	ROYAL BROWN	RB	TERRA BRONZE	TB	WHITE		MILL	ML



# Gutter Protection

BELOIT PLANT

Gutter Protection		Part #	Description	Colors	Nom. Gauge/ Thickness	Piece Length	Pieces/ Box
<b>Gutter Protection</b>							
ALGLFH55	- -	Aluminum 5"/6" Perforated High-Flow Gutter Cover with Screws 4'	AL, BK, CC, DB, EG, IV, MB, PL, RB, S1, TB, TX, WH	0.024	4'	25	
ALGLFH5M2		Aluminum 5"/6" Perforated High-Flow Gutter Cover with Screws 4'	M2	0.024	4'	25	
ALGLFS5	- -	Aluminum 5"/6" Standard Solid Gutter Cover with Screws 4'	AL, BK, CC, DB, EG, IV, MB, PL, RB, Si, TB, TX, WH	0.024	4'	25	
ALGLFS5M2		Aluminum 5"/6" Standard Solid Gutter Cover with Screws 4'	M2	0.024	4'	25	
ALGLFZCBK		Aluminum 5"/6" LF Zip Channel	BK	0.019	7'6"	20	
ALGRX5	- -	Aluminum 5" Drop-In Cover 6'	DB, WH	0.019	6'	50	
ALGRX6	- -	Aluminum 6" Drop-In Cover 6'	DB, WH	0.019	6'	50	
ALGP5CS	- -	Aluminum 5" Clean Sweep 7-1/2'	BK, WH	0.019	7'6"	40	
ALGP6CS	- -	Aluminum 6" Clean Sweep 7-1/2'	BK, WH	0.019	7'6"	40	

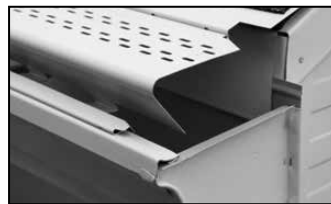

ALGLFH5 Perforated High Flow



ALGLFS5 Standard Solid



ALGLFZCBK LF Zip Channel



ALGRX5 Drop-In

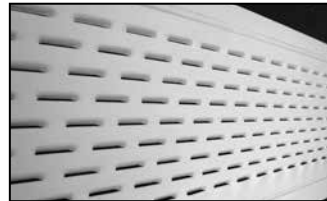

ALGP5CSWH Clean Sweep

## Gutter Protection Accessories

ALGLFM5	- -	Miters (set - 1 Left & 1 Right)	AL, BK, CC, DB, EG, IV, MB, PL, RB, Si, TB, TX, WH	0.024		10
ALGLFM5M2		Miters (set - 1 Left & 1 Right)	M2	0.024		10
ALGLFE5R	- -	End Caps (Right)	AL, BK, CC, DB, EG, IV, MB, PL, RB, Si, TB, TX, WH	0.024	5"	25
ALGLFE5RM2		End Caps (Right)	M2	0.024	5"	25
ALGLFE5L	- -	End Caps (Left)	AL, BK, CC, DB, EG, IV, MB, PL, RB, Si, TB, TX, WH	0.024	5"	25
ALGLFE5LM2		End Caps (Left)	M2	0.024	5"	25

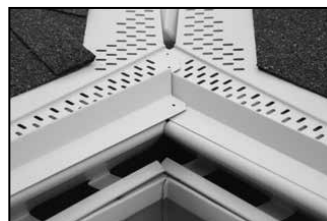

ALGLFM5 Miters



ALGLFE5 R/L End Caps

## Gutter Protection Colors:

COLOR	CODE	COLOR	CODE	COLOR	CODE	COLOR	CODE	COLOR	CODE
ALMOND	AL	CLAY	CL	IVORY	IV	ROYAL BROWN	RB	TERRA BRONZE	TB
BLACK	BK	DARK BRONZE	DB	MUSKET BROWN	MB	*RUSTIC COPPER	M2	TUXEDO GRAY	TX
CLASSIC CREAM	CC	EVERGREEN	EG	PEARL GRAY	PL	SAND	S1	30 WHITE	WH

\*Rustic Copper is a PREMIUM color. NOTE: Rustic Copper (M2) accessories, including miters and end caps, may display paint finish variations due to the metallic painting process, which may affect matching components.



# Aluminum TRIM COIL Color Selection

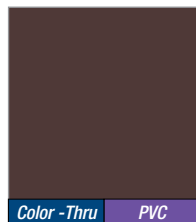

Printed Color Swatch (for color accuracy you need actual metal)

Color -Thru



Offering select products in comparable matching colors through gutter coil, rainware, soffit/fascia, trim coil or edge metal product lines

PVC

Also Available in PVC

Color -Thru PVC

Royal Brown  
B6 / RB

Trim Coil Color Code / Comparable Rainware Color Code  
Add trim coil code at end of smooth, woodgrain or PVC prefix for complete part number

Description	All Colors		Limited
	Smooth	Woodgrain	PVC
Part #	ATCS24--	ATCW24--	ATCP24--



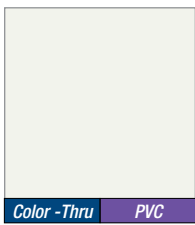

Color-Thru PVC

**WHITE**  
W1 / WH

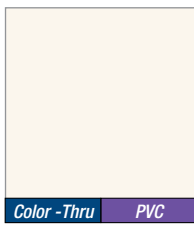

Color-Thru PVC

**LINEN**  
W10 / LN

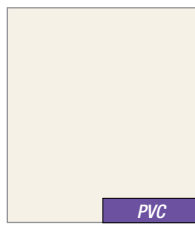

PVC

**BEIGE**  
D52

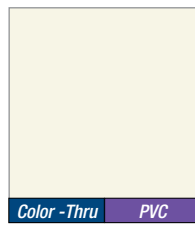

Color-Thru PVC

**ALMOND**  
D49 / AD

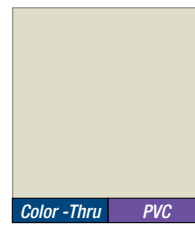

Color-Thru PVC

**TAN**  
D48 / TN

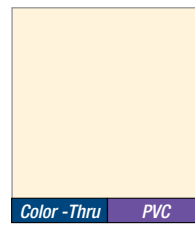

Color-Thru PVC

**CREAM**  
D22 / CC

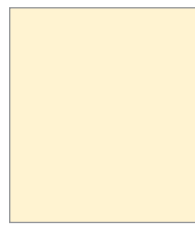

**YELLOW**  
Y4

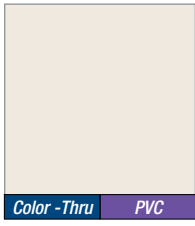

Color-Thru PVC

**CHAMPAGNE**  
D53 / CH

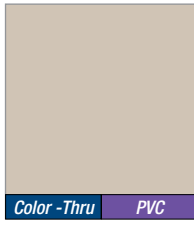

Color-Thru PVC

**SAND**  
D51 / SD

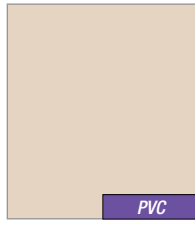

PVC

**WHEAT**  
D50

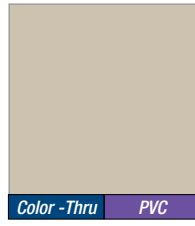

Color-Thru PVC

**SAND STONE**  
D46 / SS

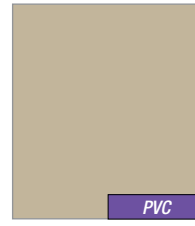

PVC

**TUMBLEWEED TAN**  
D55



Color-Thru

**NORWEGIAN WOOD**  
D26 / NW



PVC

**COBBLESTONE CLAY**  
D56



Color-Thru PVC

**SIERRA CLAY**  
D47 / Si

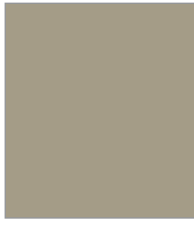

Color-Thru

**KHAKI**  
D59

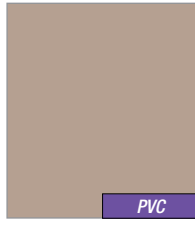

PVC

**MOCHA**  
D58

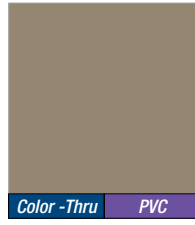

Color-Thru PVC

**RUSSET**  
B18 / RT



PVC

**MAVERICK BROWN**  
B20

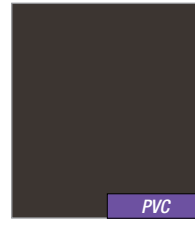

PVC

**CARBON**  
A29

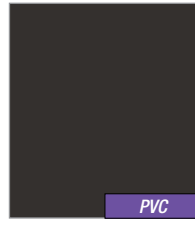

PVC

**BRONZE**  
B13



**RUSTIC CEDAR**  
D65

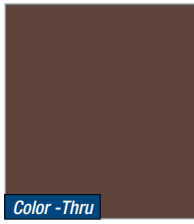

Color-Thru

**BEAVER BROWN**  
B5 / BB

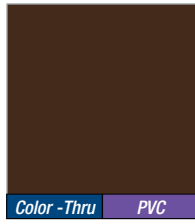

Color-Thru PVC

**MUSKET BROWN**  
B1 / MB

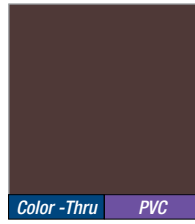

Color-Thru PVC

**ROYAL BROWN**  
B6 / RB

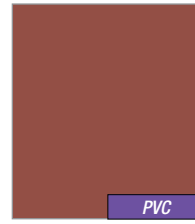

PVC

**FIREBRICK**  
R6



PVC

**GRAPHITE**  
A25

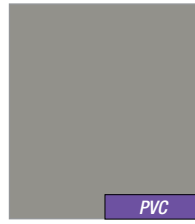

PVC

**VINTAGE GREY**  
A9

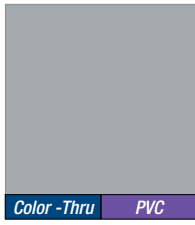

Color-Thru PVC

**GRANITE**  
A19 / GG

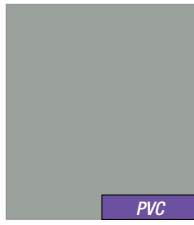

PVC

**SMOKE**  
A21



PVC

**DOVE GRAY**  
A26

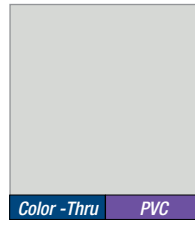

Color-Thru PVC

**SILVER GRAY**  
A3 / SG

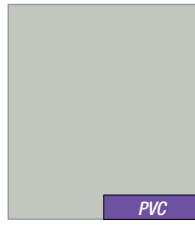

PVC

**CACTUS**  
G16



PVC

**FERN**  
A24

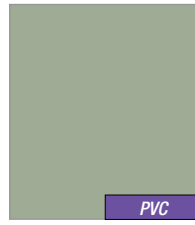

PVC

**IVY GREEN**  
G13

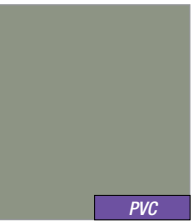

PVC

**OLIVE**  
G14



PVC

**ACADIA GREEN**  
G19

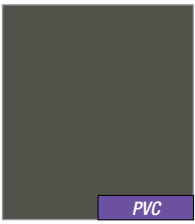

PVC

**MYRTLE**  
G17

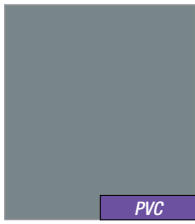

PVC

**SEAPORT**  
A22

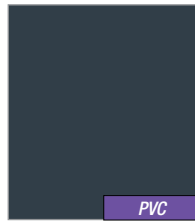

PVC

**DEEP WATER**  
L10



PVC

**JAMESTOWN BLUE**  
L2



PVC

**STEEL BLUE**  
L8

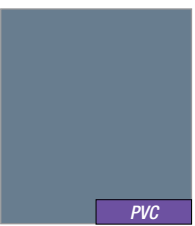

PVC

**GENEVA BLUE**  
L9

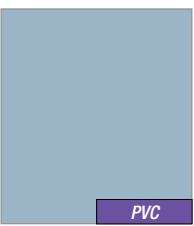

PVC

**WEDGEWOOD BLUE**  
L7

*Note: Actual color may vary from this representation. Please refer to actual metal color swatches for color accuracy. Color appearance may change when viewed at different angles or in sunlight.*

**SHERWIN-WILLIAMS**  
Coil Coatings



**NORANDEX**  
EXTERIOR PRODUCTS FOR YOUR HOME

Aluminum **TRIM COIL** Color Selection

# Trim Coil Offering

Trim Coil	Description	Piece Length	Pieces/Box	Boxes/Pallet	Pieces/Pallet	Rolls/Truck
	.019 Aluminum Trim Coil	50'	1	48	48	1248

Unless otherwise stated, all Smooth and Wood Grain trim coil is white (W1) on the opposite side.

NORANDEX™	Smooth ATCS24 --	Woodgrain ATCW24 --	PVC ATCP24 --	Rainware Comparable
Acadia Green	G19	G19	N/A	N/A
Almond	D49	D49	D49	AD
Beige	D52	D52	D52	N/A
Beaver Brown	B5	B5	N/A	BB
Beaver Brown (19")	ATCS19B5	ATCW19B5	N/A	BB
Bronze	B13	B13	B13	N/A
Cactus	G16	G16	G16	N/A
Carbon	A29	A29	A29	N/A
Champagne	D53	D53	D53	CH
Cobblestone Clay	D56	D56	D56	N/A
Cream	D22	D22	D22	CC
Deep Water	L10	L10	L10	N/A
Dove Gray	A26	A26	A26	N/A
Dune	D54	D54	N/A	CD
Fern	A24	A24	A24	N/A
Firebrick	R6	R6	R6	N/A
Geneva Blue	L9	L9	L9	N/A
Granite	A19	A19	A19	GG
Graphite	A25	A25	N/A	N/A
Ivy Green	G13	G13	G13	N/A
Jamestown Blue	L2	L2	L2	N/A
Khaki	D59	D59	N/A	N/A
Linen	W10	W10	W10	LN
Maverick Brown	B20	B20	B20	N/A
Mocha	D58	D58	D58	N/A
Musket Brown	B1	B1	B1	MB
Myrtle	G17	G17	G17	N/A
Norwegian Wood	D26	D26	N/A	NW
Olive	G14	G14	G14	N/A
Royal Brown	B6	B6	B6	RB
Russet	B18	B18	B18	RT
Rustic Cedar	D65	D65	N/A	N/A
Sand	D51	D51	D51	SD
Sand Stone	D46	D46	D46	SS
Seaport	A22	A22	A22	N/A
Sierra	D47	D47	D47	SI
Silver	A3	A3	A3	SG
Smoke	A21	A21	A21	N/A
Steel Blue	L8	L8	L8	N/A
Tan	D48	D48	D48	TN
Tumbleweed Tan	D55	D55	D55	N/A
Vintage Grey	A9	A9	A9	N/A
Wedgewood Blue	L7	L7	L7	N/A
Wheat	D50	D50	D50	N/A
White	W1	W1	W1	WH
Yellow	Y4	Y4	N/A	N/A

MASTIC	Smooth ATCS24 --	Woodgrain ATCW24 --	PVC ATCP24 --	Rainware Comparable
Almond	D14	D14	D14	AL
Alpine Forest (Solar Def.)	C7	C7	N/A	N/A
Autumn Harvest	B11	B11	N/A	N/A
Black	A17	A17	A17	BK
Brookstone	D21	D21	D21	B5
Buckskin	D27	D27	N/A	BU
Cameo	W2	W2	W2	CA
Cape Cod Grey	A2	A2	A2	HG
Charcoal Grey	A8	A8	N/A	CG
Classic Cream	D22	D22	D22	CC
Corn Silk	D24	D24	N/A	N/A
Country Blue	L3	L3	N/A	CU
Dark Bronze	B13	B13	B13	N/A
Deep Granite	A9	A9	N/A	N/A
Desert Sand	D34	D34	D34	DS
English Wedgewood	A11	A11	N/A	N/A
Everest	A15	A15	N/A	EV
Evergreen	G6	G6	G6	EG
Harbor Grey	A2	A2	A2	HG
Lakeshore Fern	G2	G2	N/A	N/A
Linen	D4	D4	D4	LI
Misty Shadow	A10	A10	N/A	N/A
Montana Suede	D44	D44	D44	MS
Musket Brown	B1	B1	B1	MB
Natural Cedar	B9	B9	N/A	MB
Natural Slate (Solar Def.)	A23	A23	N/A	N/A
Newport Bay (Solar Def.)	L2	L2	L2	N/A
Pebblestone Clay	D5	D5	D5	PC
Portsmouth Blue	L6	L6	N/A	N/A
Quiet Willow	G12	G12	N/A	N/A
Red Brick (Solar Def.)	R8	R8	N/A	N/A
Redwood	R3	R3	N/A	RW
Royal Brown	B6	B6	B6	RB
Rugged Canyon	B9	B9	N/A	N/A
Russet Red	R4	R4	N/A	N/A
Sage	D25	D25	N/A	SA
Sandtone	D6	D6	D6	ST
Scottish Thistle	G9	G9	N/A	N/A
Silver Grey	A3	A3	A3	SG
Terra Bronze	B12	B12	B12	TB
Victorian Grey	A5	A5	A5	VG
Village Green	G11	G11	N/A	VI
Vineyard Grove	G7	G7	N/A	N/A
Vintage Brick	R1	R1	R1	N/A
Vintage Dublin	G17	G17	G17	N/A
White	W1	W1	W1	WH
Wicker	D8	D8	D8	WI
Whispering Timber	C5	C5	N/A	N/A
Woodland Retreat (Sol. Def.)	A29	A29	A29	N/A

SPECIALTY COILS	Smooth Part #	Wood Grain Part #	Description	Piece Length	Nom. Ga.	Rolls/Pallet
Black/Royal Brown	ATCS7B14	ATCW7B14	Alum. 7"	50'	0.019	48
Black/Royal Brown	ATCS14B14	ATCW14B14	Alum. 14"	50'	0.019	48
Black/Royal Brown	ATCS24B14	ATCW24B14	Alum. 24"	50'	0.019	48
Black/Royal Brown	ATCS224B14	ATCW224B14	Alum. 24"	50'	0.024	32
Mastic White	ATCS14W1	ATCW14W1	Alum. 14"	50'	0.019	48
Mastic White	ATCS224W1	ATCW224W1	Alum. 24"	50'	0.024	32
Musket Brown	ATCS224B1	ATCW224B1	Alum. 24"	50'	0.024	32
Pebblestone Clay/White	ATCS224D5W	ATCW224D5W	Alum. 24"	50'	0.024	32
Victorian Grey	ATCS14A5	ATCW14A5	Alum. 14"	50'	0.019	48
Any Smooth TC Color	ATCS415 --	ATCW415 --	Alum. 24"	150'	0.019	18

TEXTURED	Textured ATCT24 --	NOTE: Textured Trim Coil is painted white on reverse side.
Clay	D39	
Tan	D38	
White	W4	

PROUDLY FINISHED WITH  
**SHERWIN-WILLIAMS.**  
 Coil Coatings

# Trim Coil Offering

Trim Coil	Description	Piece Length	Pieces/Box	Boxes/Pallet	Pieces/Pallet	Rolls/Truck
	.019 Aluminum Trim Coil	50'	1	48	48	1248

*Unless otherwise stated, all Smooth and Wood Grain trim coil is white (W1) on the opposite side.*

CERTAINTEED	Smooth ATCS24 --	Woodgrain ATCW24 --	PVC ATCP24 --	Rainware Comparable
Autumn Red	R6	R6	R6	N/A
Buckskin	D23	D23	N/A	N/A
Castle Stone	A21	A21	A21	N/A
Charcoal Gray	A9	A9	N/A	N/A
Cypress	G1	G1	G1	N/A
Desert Tan	D13	D13	D13	N/A
Flagstone	A12	A12	N/A	N/A
Forest	G17	G17	G17	N/A
Granite Gray	A2	A2	A2	N/A
Hearthstone	B10	B10	N/A	N/A
Heritage Cream	Y1	Y1	Y1	N/A
Herringbone	D37	D37	D37	N/A
Light Maple	D12	D12	D12	N/A
Linen	D7	D7	D7	N/A
Mountain Cedar	B11	B11	N/A	N/A
Musket Brown	B2	B2	B2	N/A
Natural Clay	D47	D47	D47	SI
Oxford Blue	L1	L1	L1	N/A
Pacific Blue	L8	L8	L8	N/A
Sable Brown	B20	B20	B20	N/A
Sandstone Beige	D18	D18	D18	N/A
Savannah Wicker	D8	D8	D8	WI
Seagrass	G9	G9	G9	N/A
Silver Ash	D19	D19	N/A	N/A
Slate	A29	A29	A29	N/A
Smokey Gray	A10	A10	N/A	N/A
Snow	W1	W1	W1	N/A
Spruce	G5	G5	N/A	N/A
Sterling Gray	A14	A14	A14	N/A
Wedgewood Blue	C9	C9	N/A	N/A

ROYAL	Smooth ATCS24 --	Woodgrain ATCW24 --	PVC ATCP24 --	Rainware Comparable
Beige	D10	D10	D10	N/A
Brownstone	D26	D26	N/A	NW
Clay	D21	D21	D21	BS
Cypress	G1	G1	G1	N/A
Driftwood	D37	D37	N/A	N/A
Flagstone	A1	A1	A1	N/A
Granite	A25	A25	A25	GG
Harvard Slate	A2	A2	A2	HG
Heather	G8	G8	G8	N/A
Ironstone	C7	C7	N/A	N/A
Linen	W10	W10	W10	LN
Marine Blue	C12	C12	N/A	N/A
Midnight Surf	L10	L10	L10	N/A
Natural Cedar	D65	D65	D65	N/A
Pebble Clay	D5	D5	D5	PC
Redwood	R6	R6	R6	N/A
Rockslide	A9	A9	N/A	N/A
Sand	D7	D7	D7	N/A
Shamrock	G17	G17	G17	N/A
Soft Maple	D12	D12	D12	N/A
Sterling	A3	A3	A3	SG
Storm	A22	A22	A22	N/A
Tree Moss	G12	G12	G12	N/A
Urban Bronze	C14	C14	N/A	N/A
Vintage Cream	D30	D30	D30	N/A
Wicker	D8	D8	D8	WI
Walnut	B9	B9	N/A	N/A

VARIFORM	Smooth ATCS24 --	Woodgrain ATCW24 --	PVC ATCP24 --	Rainware Comparable
Autumn Beige	D31	D31	N/A	N/A
Briarwood	B9	B9	N/A	N/A
Classic Cream	D22	D22	D22	CC
Delray Sand	Y1	Y1	Y1	N/A
Flint	A7	A7	N/A	N/A
Georgian Gray	A4	A4	A4	N/A
Irish Thistle	A1	A1	A1	N/A
Island Pearl	W2	W2	W2	CA
Mediterranean Palm	G2	G2	N/A	N/A
Natural Almond	D13	D13	D13	N/A
Sagebrook	G12	G12	N/A	N/A
Sandtone	D6	D6	D6	ST
Sandy Tan	D33	D33	D33	N/A
Silver Mist	D37	D37	D37	N/A
Stone Mountain Clay	D47	D47	D47	SI
Twilight Shadow	A10	A10	N/A	N/A
Wedgewood	A11	A11	N/A	N/A

EXTERIOR PORTFOLIO	Smooth ATCS24 --	Woodgrain ATCW24 --	PVC ATCP24 --	Rainware Comparable
Aspen White	W1	W1	W1	WH
Bone	D37	D37	D37	HN
Carbon	C7	C7	N/A	N/A
Clay	D47	D47	D47	SI
Cypress	G1	G1	G1	N/A
Espresso	B12	B12	B12	TB
Graphite	A25	A25	N/A	N/A
Greystone	A2	A2	A2	HG
Honey Oak	D23	D23	N/A	N/A
Indigo	C12	C12	C12	N/A
Ivory	D10	D10	D10	N/A
Lighthouse Red	R1	R1	R1	N/A
Metropolitan Gray	A9	A9	N/A	N/A
Mocha	D19	D19	D19	N/A
Oceanside	A22	A22	A22	N/A
Olive	G2	G2	N/A	N/A
Pearl	W2	W2	W2	CA
Peppercorn	C14	C14	N/A	N/A
Regatta Blue	L2	L2	L2	N/A
Saddle	D6	D6	D6	ST
Slate	A23	A23	N/A	N/A
Smoke Ash	B18	B18	B18	RT
Spruce	G17	G17	G17	N/A
Wheat	Y1	Y1	Y1	N/A
Wicker	D8	D8	D8	WI

JAMES HARDIE	Smooth ATCS24 --	Woodgrain ATCW24 --	PVC ATCP24 --
Aged Pewter / Deep Ocean	C12	C12	N/A
Arctic White / Woodstock Brown	C2	C2	N/A
Chestnut Brown / Evening Blue	C8	C8	N/A
Cobblestone / Autumn Tan	C6	C6	N/A
Heathered Moss / Boothbay Blue	C9	C9	N/A
Iron Gray / Countrylane Red	C7	C7	N/A
Khaki Brown / Sail Cloth	C1	C1	N/A
Monterey Taupe / Sandstone Beige	C11	C11	N/A
Mountain Sage / Light Mist	C10	C10	N/A
Navajo Beige / Timber Bark	C5	C5	N/A
Night Gray / Pearl Gray	C13	C13	N/A
Rich Espresso / Gray Slate	C14	C14	N/A
Sandstone Beige (PVC only)	N/A	N/A	D15

# Trim Coil Offering

Trim Coil	Description	Piece Length	Pieces/Box	Boxes/Pallet	Pieces/Pallet	Rolls/Truck
	.019 Aluminum Trim Coil	50'	1	48	48	1248

*Unless otherwise stated, all Smooth and Wood Grain trim coil is white (W1) on the opposite side.*

ALLURA'S COLORMAX®	Smooth ATCS24 --	Woodgrain ATCW24 --	PVC ATCP24 --	Rainware Comparable
Ashen	C6	C6	N/A	N/A
Autumn Red	R6	R6	R6	N/A
Bark	C14	C14	N/A	N/A
Cool Charcoal	C12	C12	N/A	N/A
Desert Tan	D13	D13	D13	N/A
Flagstone	A22	A22	A22	N/A
Granite Gray	A2	A2	A2	N/A
Hearthstone	B10	B10	N/A	N/A
Linen	D7	D7	D7	N/A
Natural Clay	D26	D26	N/A	N/A
Pacific Blue	L8	L8	L8	N/A
Rock Cliffs	C6	C6	N/A	N/A
Sable Brown	B20	B20	B20	N/A
Savannah Wicker	D8	D8	D8	N/A
Snow	W1	W1	W1	WH
Sterling Gray	A28	A28	A28	N/A
Taupe	D47	D47	D47	SI

LP® SIDING SMARTSIDE®	Smooth ATCS24 --	Woodgrain ATCW24 --	PVC ATCP24 --	Rainware Comparable
Abyss Black	A27	A27	A27	N/A
Desert Stone	C6	C6	N/A	N/A
Garden Sage	G2	G2	N/A	N/A
Harvest Honey	D23	D23	N/A	N/A
Midnight Shadow	A23	A23	N/A	N/A
Prairie Clay	D47	D47	D47	SI
Quarry Gray	A31	A31	N/A	N/A
Rapids Blue	L11	L11	N/A	N/A
Redwood Red	R8	R8	N/A	N/A
Sand Dunes	D48	D48	D48	TN
Snowscape White	W6	W6	W6	N/A
Summit Blue	C9	C9	N/A	N/A
Terra Brown	C1	C1	N/A	N/A
Timberland Suede	C2	C2	N/A	N/A
Tundra Gray	C12	C12	N/A	N/A

EVERLAST®	Smooth ATCS24 --	Woodgrain ATCW24 --	PVC ATCP24 --	Textured ATCT24 --	Rainware Comparable
Antique Ivory	D22	D22	D22	N/A	CC
Blue Spruce	L10	L10	L10	N/A	N/A
Chestnut	B9	B9	N/A	N/A	N/A
Flagstone	A22	A22	A22	N/A	N/A
Misty Taupe	D47	D47	D47	N/A	SI
Natural White	N/A	N/A	N/A	W4	N/A
Saddle Wood	C14	C14	N/A	N/A	N/A
Sand Dune	C6	C6	N/A	N/A	N/A
Seaside Grey	N/A	N/A	N/A	M1	N/A
Slate	A19	A19	A19	N/A	GG
Spanish Moss	G12	G12	N/A	N/A	N/A
Storm Grey	L10	L10	L10	N/A	N/A
Willow	G1	G1	G1	N/A	N/A

EXTREME WINDOWS BY NORANDEX™	Smooth ATCS24 --	Woodgrain ATCW24 --	PVC ATCP24 --	Rainware Comparable
Almond	D62	D62	D62	N/A
Brick Red	R3	R3	N/A	RW
Bronze	B13	B13	N/A	N/A
Clay	D56	D56	D56	N/A
Dark Chocolate	B2	B2	B2	N/A
Hunter Green	G20	G20	N/A	N/A
Tan	D33	D33	D33	N/A
Terratone	C5	C5	N/A	N/A
White	W11	W11	N/A	N/A

PERFEXION BY NORANDEX™	Smooth ATCS24 --	Woodgrain ATCW24 --	PVC ATCP24 --	Textured ATCT24 --	Rainware Comparable
Black	A17	A17	N/A	N/A	BK
Brick	R3	R3	N/A	N/A	RW
Bronze	B13	B13	N/A	N/A	N/A
Chocolate	B6	B6	B6	N/A	RB
Cream	D14	D14	D14	N/A	AL
Driftwood	G20	G20	N/A	N/A	N/A
Extruded Driftwood	G8	G8	G8	N/A	N/A
Extruded Tan	N/A	N/A	N/A	D38	N/A
Extruded White	W1	W1	W1	N/A	WH
Pine	G18	G18	G18	N/A	N/A
Tan	N/A	N/A	N/A	D38	N/A

PELLA® WINDOW	Smooth ATCS24 --	Woodgrain ATCW24 --	PVC ATCP24 --	Rainware Comparable
Almond	D62	D62	N/A	N/A
Black	A27	A27	A17	N/A
Brick Red	R7	R7	N/A	N/A
Brown	B22	B22	N/A	N/A
Fossil	D66	D66	N/A	N/A
Hartford Green	G20	G20	G18	N/A
Morning Sky	A28	A28	A28	N/A
Poplar White	D61	D61	N/A	N/A
Portobello	B23	B23	N/A	N/A
Putty	D63	D63	N/A	N/A
Tan	D64	D64	N/A	N/A
White	C2	C2	N/A	N/A

ANDERSEN® WINDOWS	Smooth ATCS24 --	Woodgrain ATCW24 --	PVC ATCP24 --	Rainware Comparable
Black	A30	A30	N/A	N/A
Canvas	W12	W12	N/A	N/A
Cocoa Bean	B26	B26	N/A	N/A
Dark Bronze	B25	B25	N/A	N/A
Forest Green	G20	G20	N/A	N/A
Sandtone	D66	D66	N/A	N/A
Terratone	B24	B24	N/A	N/A
White	W11	W11	N/A	N/A
<i>All Andersen® trim coil above is white (W11) on the opposite side.</i>				
Dark Bronze/Terratone	C15	C15	N/A	N/A
Black/Terratone	C16	C16	N/A	N/A

PROUDLY FINISHED WITH  
**SHERWIN-WILLIAMS.**  
 Coil Coatings



4" Fascia	Part #	Description	Colors	Nom. Gauge/ Thickness	Piece Length	Pieces/ Box	Boxes/ Pallet	Pieces/ Pallet
	AFCR4 - -	Aluminum 4" Ribbed Fascia	DS, EG, LI, PC, RB, ST, TB, WH, WI	0.024	12'	25	24	600

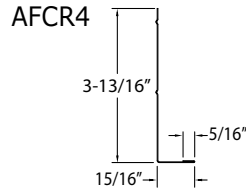

6" Fascia	Part #	Description	Colors	Nom. Gauge/ Thickness	Piece Length	Pieces/ Box	Boxes/ Pallet	Pieces/ Pallet
	AFCS6 - -	Aluminum 6" Smooth Fascia	(Listed Below)	0.024	12'	25	24	600
	AFCR6 - -	Aluminum 6" Ribbed Fascia	(Listed Below)	0.024	12'	25	24	600
	AFCE6 - -	Aluminum 6" No. Pine Wood Grain	(Listed Below)	0.024	12'	25	24	600
	GFCE6 - -	Galvanized 6" No. Pine Wood Grain	TB, WH	26 ga	12'	10	24	240



**Note:** Aluminum coil will not match steel fascia due to a different coating process.

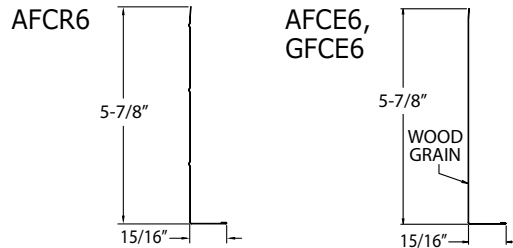

### Fascia Colors | ●=Color-Thru System™

COLOR	CODE	COLOR	CODE	COLOR	CODE	COLOR	CODE
• NX ALMOND	D49	• NX CHAMPAGNE	D53	• HARBOR GREY	HG	• REDWOOD	RW
• ALMOND	AL	• CHARCOAL GREY	CG	• NX LINEN	W10	• ROYAL BROWN	RB
• BEAVER BROWN	BB	• CLASSIC CREAM	CC	• LINEN	LI	• NX RUSSET	B18
• BLACK	BK	• COUNTRY BLUE	CU	• MONTANA SUEDE	XMS	• SAGE	SA
• BRONZE	BZ	• DESERT SAND	DS	• MUSKET BROWN	MB	• NX SAND	D51
• BUCKSKIN	BU	• EVEREST	EV	• NORWEGIAN WOOD	NW	• NX SAND STONE	D46
• CAMEO	CA	• EVERGREEN	EG	• PEBBLESTONE CLAY	PC		
		• NX GRANITE	A19			• SANDTONE	ST
						• NX SIERRA CLAY	D47
						• SILVER	SG
						• NX TAN	D48
						• TERRA BRONZE	TB
						• VICTORIAN GREY	VG
						• WHITE	WH
						• WICKER	WI



# NORANDEX™ Fascia

BELOIT PLANT

8" Fascia		Part #	Description	Colors	Nom. Gauge/ Thickness	Piece Length	Pieces/ Box	Boxes/ Pallet	Pieces/ Pallet
	AFCS8 - -	Aluminum 8" Smooth Fascia	(Listed Below)	0.024	12'	25	20	500	
	AFCR8 - -	Aluminum 8" Ribbed Fascia	(Listed Below)	0.024	12'	25	20	500	
	AFCE8 - -	Aluminum 8" No. Pine Wood Grain	(Listed Below)	0.024	12'	25	20	500	
	GFCE8 - -	Galvanized 8" No. Pine Wood Grain	RB, WH	26 ga	12'	10	20	200	

**Note:** Aluminum coil will not match steel fascia due to a different coating process.

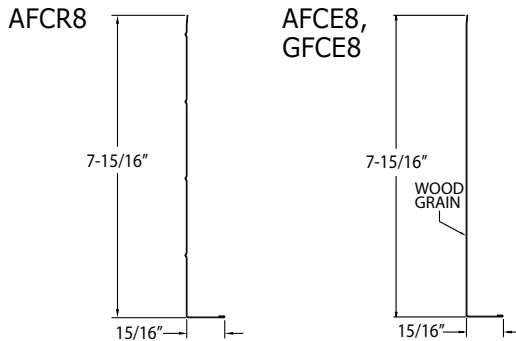

10" Fascia		Part #	Description	Colors	Nom. Gauge/ Thickness	Piece Length	Pieces/ Box	Boxes/ Pallet	Pieces/ Pallet
	AFCS10WH	Aluminum 10" Smooth Fascia	WH	0.024	12'	25	8	200	
	AFCR10WH	Aluminum 10" Ribbed Fascia	WH	0.024	12'	25	8	200	
	AFCE10WH	Alum. 10" No. Pine Wood Grain	WH	0.024	12'	25	8	200	

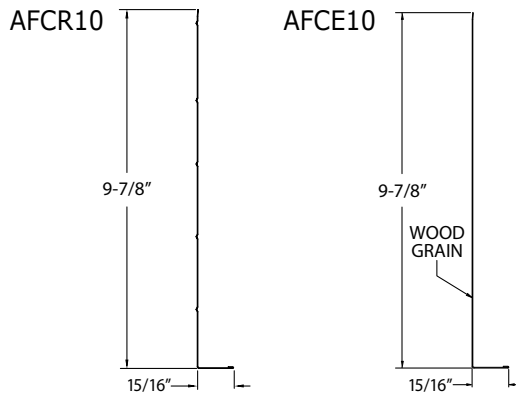

### Fascia Colors | ●=Color-Thru System™

COLOR	CODE	COLOR	CODE	COLOR	CODE	COLOR	CODE	COLOR	CODE
● NX ALMOND	D49	● NX CHAMPAGNE	D53	● HARBOR GREY	HG	● REDWOOD	RW	● SANDTONE	ST
● ALMOND	AL	● CHARCOAL GREY	CG	● NX LINEN	W10	● ROYAL BROWN	RB	● NX SIERRA CLAY	D47
● BEAVER BROWN	BB	● CLASSIC CREAM	CC	● LINEN	LI	● NX RUSSET	B18	● SILVER	SG
● BLACK	BK	● COUNTRY BLUE	CU	● MONTANA SUEDE	XMS	● RUSTIC COPPER	M2	● NX TAN	D48
● BRONZE	BZ	● DESERT SAND	DS	● MUSKET BROWN	MB	● SAGE	SA	● TERRA BRONZE	TB
● BUCKSKIN	BU	● EVEREST	EV	● NORWEGIAN WOOD	NW	● NX SAND	D51	● VICTORIAN GREY	VG
● CAMEO	CA	● EVERGREEN	EG	● PEBBLESTONE CLAY	PC	● NX SAND STONE	D46	● WHITE	WH
		● NX GRANITE	A19					● WICKER	WI



## 12" Hidden Vent Soffit

Part #	Description	Colors	Nom. Gauge/ Thickness	Piece Length	Pieces/ Box	Boxes/ Pallet	Pieces/ Pallet	Squares/ Box
AST12HV - -	Alum. 12" Hidden Vent	AL, BK, BZ, CA, DS, HG, MB, PC, RB, ST, TB, VG, WH, WI	0.019	12'	16	24	384	1.92

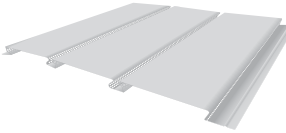

**NOTE:** Requires 1/2" J- or F-Channel for installation.

Hidden Vent Soffit NFA 10.3 sq. in. / sq. ft.

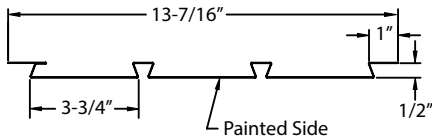

## 12" Double 6 D6 Soffit

Part #	Description	Colors	Nom. Gauge/ Thickness	Piece Length	Pieces/ Box	Boxes/ Pallet	Pieces/ Pallet	Squares/ Box
ASTD6S - -	Aluminum Solid	MB, PC, RB, D46, D47, TB, WH, WI	0.019	12'	16	24	384	1.92
ASTD6V - -	Aluminum Full Vent	MB, PC, RB, D46, D47, TB, WH, WI	0.019	12'	16	24	384	1.92

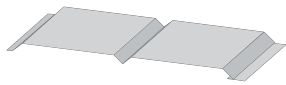

**NOTE:** Requires 1/2" J- or F-Channel for installation.

D6 Soffit NFA 10.37 sq. in. / sq. ft.

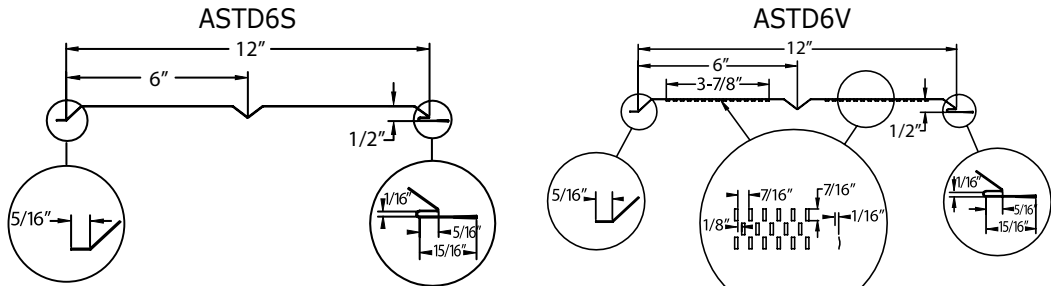

## 12" Soffit

Part #	Description	Colors	Nom. Gauge/ Thickness	Piece Length	Pieces/ Box	Boxes/ Pallet	Pieces/ Pallet	Squares/ Box
AST12S - -	Aluminum Solid	*(Listed Below)	0.019	12'	20	15	300	2.4
AST12CV - -	Aluminum Center Vent	(Listed Below)	0.019	12'	20	15	300	2.4
AST12FV - -	Aluminum Full Vent	(Listed Below)	0.019	12'	20	15	300	2.4
AST212S--	Aluminum Solid	BK, MB, PC, RB, WH	0.024	12'	20	15	300	2.4
AST212FV--	Aluminum Full Vent	BK, MB, PC, RB, WH	0.024	12'	20	15	300	2.4

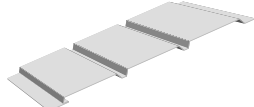

**NOTE:** Requires 3/8" accessory channels. .024 Soffit recommended for full span applications.

Full Vent NFA 17.93 sq. in. / sq. ft. Center Vent NFA 6.19 sq. in. / sq. ft.

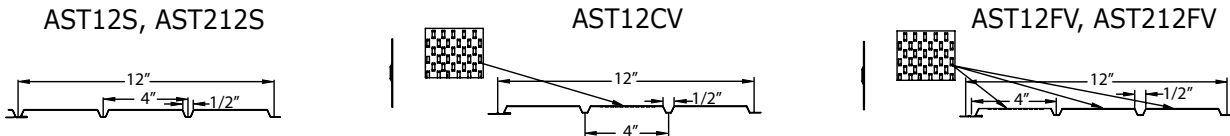

## 16" Soffit

Part #	Description	Colors	Nom. Gauge/ Thickness	Piece Length	Pieces/ Box	Boxes/ Pallet	Pieces/ Pallet	Squares/ Box
AST16S - -	Aluminum Solid	(Listed Below)	0.019	12'	10	20	200	1.6
AST16CV - -	Aluminum Center Vent	(Listed Below)	0.019	12'	10	20	200	1.6
AST16FV - -	Aluminum Full Vent	(Listed Below)	0.019	12'	10	20	200	1.6

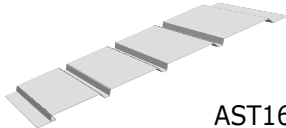

**NOTE:** Requires 3/8" accessory channels.

Full Vent NFA 17.98 sq. in. / sq. ft. Center Vent NFA 8.99 sq. in. / sq. ft.

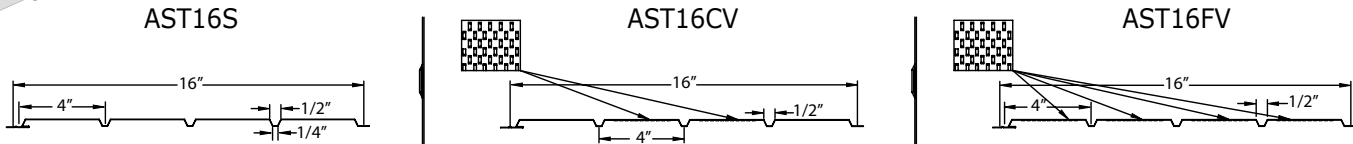

### Soffit Colors | • = Color-Thru System™

COLOR	CODE	COLOR	CODE	COLOR	CODE	COLOR	CODE	COLOR	CODE
• NX ALMOND	D49	• CHARCOAL GREY	CG	• NX LINEN	W10	• ROYAL BROWN	RB	• TERRA BRONZE	TB
• ALMOND	AL	• CLASSIC CREAM	CC	• LINEN	LI	• NX RUSSET	B18	• VICTORIAN GREY	VG
• BEAVER BROWN	BB	• COUNTRY BLUE	CU	• MONTANA SUEDE	XMS	• SAGE	SA	• WHITE	WH
• BLACK	BK	• DESERT SAND	DS	• MUSKET BROWN	MB	• NX SAND	D51	• WICKER	WI
• BRONZE	BZ	• EVEREST	EV	• NORWEGIAN WOOD	NW	• NX SAND STONE	D46		
• BUCKSKIN	BU	• EVERGREEN	EG	• PEBBLESTONE CLAY	PC	• SANDTONE	ST		
• CAMEO	CA	• NX GRANITE	A19	• REDWOOD	RW	• NX SIERRA CLAY	D47		
• NX CHAMPAGNE	D53	• HARBOR GREY	HG			• SILVER	SG		
						• NX TAN	D48		



# NORANDEX™ Siding Accessories

BELOIT PLANT

## F-Channel

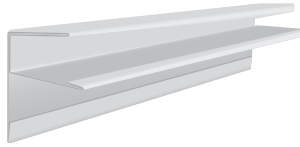

Part #	Description	Colors	Nom. Gauge/ Thickness	Piece Length	Pieces/ Box	Boxes/ Pallet	Pieces/ Pallet
AUF38 - -	Alum. 3/8" Universal F-Channel	*(Listed Below)	0.019	12'	25	24	600
AF12 - -	Alum. 1/2" F-Channel	AL, BK, BZ, CA, DS, HG, MB, D46, D47, PC, RB, ST, TB, VG, WH, WI	0.019	12'	25	24	600
AF58 - -	Alum. 5/8" F-Channel	PC, WH	0.019	12'	30	20	600

\*AUF38 not available in Hardie colors.

★ "U" Status: Use up until gone.

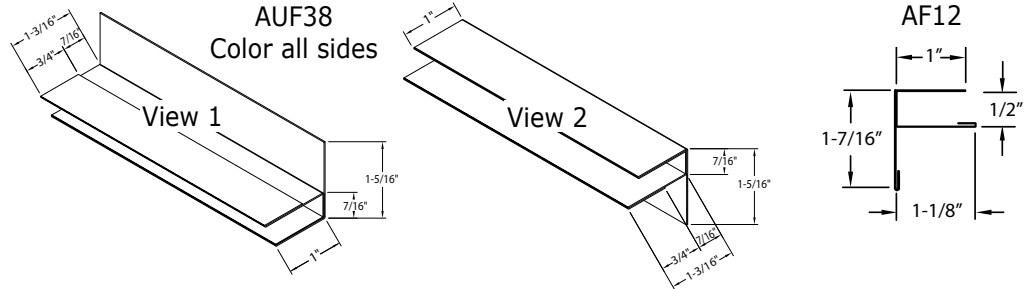

### F-Channel Colors: | ● = Color-Thru System™

COLOR	CODE	COLOR	CODE	COLOR	CODE	COLOR	CODE	COLOR	CODE
● NX ALMOND	D49	● NX CHAMPAGNE	D53	● EVERGREEN	EG	● REDWOOD	RW	● NX SIERRA CLAY	D47
● ALMOND	AL	● CHARCOAL GREY	CG	● NX GRANITE	A19	● ROYAL BROWN	RB	● SILVER	SG
● BEAVER BROWN	BB	● CLASSIC CREAM	CC	● HARBOR GREY	HG	● NX RUSSET	B18	● NX TAN	D48
● BLACK	BK	● COUNTRY BLUE	CU	● NX LINEN	W10	● SAGE	SA	● TERRA BRONZE	TB
● BRONZE	BZ	● DESERT SAND	DS	● LINEN	LI	● NX SAND	D51	● VICTORIAN GREY	VG
● BUCKSKIN	BU	● EVEREST	EV	● MUSKET BROWN	MB	● NX SAND STONE	D46	● WICKER	WI
● CAMEO	CA			● NORWEGIAN WOOD	NW	● SANDTONE	ST	● WHITE	WH
				● PEBBLESTONE CLAY	PC				

## J-Channel

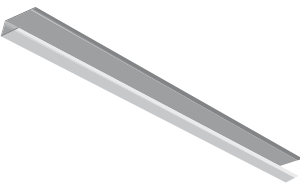

Part #	Description	Colors	Nom. Gauge/ Thickness	Piece Length	Pieces/ Box	Boxes/ Pallet	Pieces/ Pallet
AJ38 - -	Alum. 3/8" J-Channel	(Listed Below)	0.019	12'	25	24	600
AJ12 - -	Alum. 1/2" J-Channel	AL, BK, BZ, CA, DS, HG, MB, D46, D47, PC, RB, ST, TB, VG, WH, WI	0.019	12'	25	24	600
AJ58 - -	Alum. 5/8" J-Channel	PC, WH	0.019	12'	25	24	600

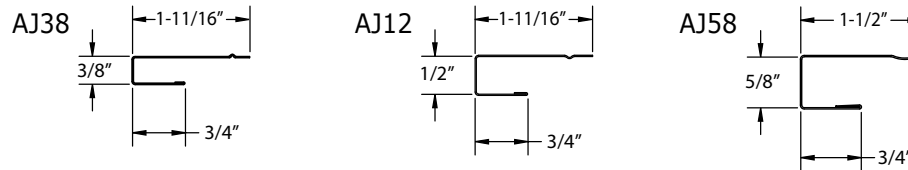

## Miter Divider



Part #	Description	Colors	Nom. Gauge/ Thickness	Piece Length	Pieces/ Box	Boxes/ Pallet
AMD38 - -	Alum. 3/8" Miter Divider	(Listed Below)	0.019	10'	10	24

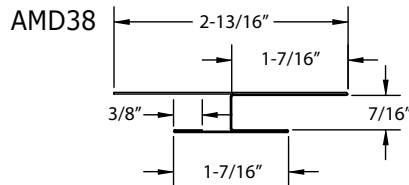

### J-Channel & Miter Divider Colors | ● = Color-Thru System™

COLOR	CODE	COLOR	CODE	COLOR	CODE	COLOR	CODE	COLOR	CODE
● NX ALMOND	D49	● CHARCOAL GREY	CG	● NX LINEN	W10	● ROYAL BROWN	RB	● TERRA BRONZE	TB
● ALMOND	AL	● CLASSIC CREAM	CC	● LINEN	LI	● NX RUSSET	B18	● VICTORIAN GREY	VG
● BEAVER BROWN	BB	● COUNTRY BLUE	CU	● MONTANA SUEDE	XMS	● SAGE	SA	● WHITE	WH
● BLACK	BK	● DESERT SAND	DS	● MUSKET BROWN	MB	● NX SAND	D51	● WICKER	WI
● BRONZE	BZ	● EVEREST	EV	● NORWEGIAN WOOD	NW	● NX SAND STONE	D46		
● BUCKSKIN	BU	● EVERGREEN	EG	● PEBBLESTONE CLAY	PC	● SANDTONE	ST		
● CAMEO	CA	● NX GRANITE	A19	● REDWOOD	RW	● NX SIERRA CLAY	D47		
● NX CHAMPAGNE	D53	● HARBOR GREY	HG			● SILVER	SG		
						● NX TAN	D48		





# NORANDEX™ Siding Accessories

BELOIT PLANT

## Siders Edge

Part #	Description	Colors	Nom. Gauge/ Thickness	Piece Length	Pieces/ Box	Boxes/ Pallet	Pieces/ Pallet
ASE310 - -	Aluminum 3" Siders Edge	(Listed Below)	0.019	10'	25	24	600

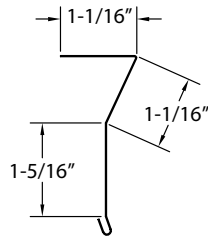
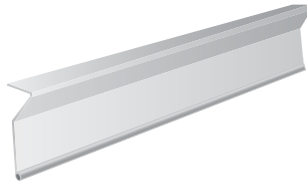

## Starter Strip

Part #	Description	Colors	Nom. Gauge/ Thickness	Piece Length	Pieces/ Box	Boxes/ Pallet	Pieces/ Pallet
ASS25ML	Aluminum 2-1/2" Starter Strip	Mill	0.019	10'	50	24	1200
ASS35ML	Aluminum 3-1/2" Starter Strip	Mill	0.019	10'	25	24	600
GSS25ML	Galv. 2-1/2" Starter Strip	Mill	28 ga	10'	50	24	1200
GSS35ML	Galv. 3-1/2" Starter Strip	Mill	28 ga	10'	25	24	600
GSSS35	Galv. 3-1/2" Norandex Shake Starter Strip	Mill	28 ga	10'	25	24	600



ASS25ML, GSS25ML

ASS35ML, GSS35ML

GSSS35

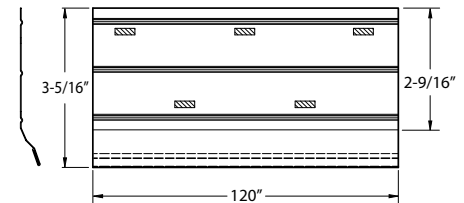
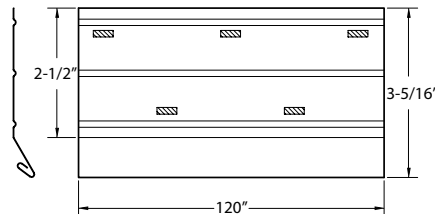
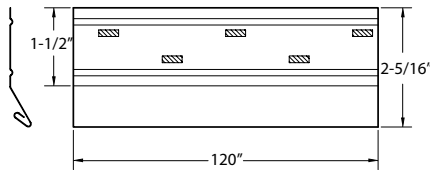

## Z-Flashing

Part #	Description	Colors	Nom. Gauge/ Thickness	Piece Length	Pieces/ Box	Boxes/ Pallet	Pieces/ Pallet
AZF38 - -	Aluminum 3/8" Z-Flashing	(Listed Below)	0.019	10'	25	20	500
AZF38ML	Aluminum 3/8" Z-Flashing	Mill	0.019	10'	25	20	500
AZF44 - -	Aluminum 7/16" Z-Flashing	(Listed Below)	0.019	10'	25	20	500
AZF44ML	Aluminum 7/16" Z-Flashing	Mill	0.019	10'	25	20	500
AZF50 - -	Aluminum 1/2" Z-Flashing	(Listed Below)	0.019	10'	25	20	500
AZF50ML	Aluminum 1/2" Z-Flashing	Mill	0.019	10'	25	20	500
AZF62 - -	Aluminum 5/8" Z-Flashing	(Listed Below)	0.019	10'	25	20	500
AZF62ML	Aluminum 5/8" Z-Flashing	Mill	0.019	10'	25	20	500
AZF75 - -	Aluminum 3/4" Z-Flashing	(Listed Below)	0.019	10'	25	20	500
AZF75ML	Aluminum 3/4" Z-Flashing	Mill	0.019	10'	25	20	500
GZF38 - -	Galvanized 3/8" Z-Flashing	BK, RB, TB, WH	28 ga	10'	25	20	500
GZF38ML	Galvanized 3/8" Z-Flashing	Mill	28 ga	10'	25	20	500
GZF44ML	Galvanized 7/16" Z-Flashing	Mill	28 ga	10'	25	20	500
GZF50 - -	Galvanized 1/2" Z-Flashing	BK, RB, TB, WH	28 ga	10'	25	20	500
GZF50ML	Galvanized 1/2" Z-Flashing	Mill	28 ga	10'	25	20	500
GZF62 - -	Galvanized 5/8" Z-Flashing	BK, RB, TB, WH	28 ga	10'	25	20	500
GZF62ML	Galvanized 5/8" Z-Flashing	Mill	28 ga	10'	25	20	500
GZF75 - -	Galvanized 3/4" Z-Flashing	BK, RB, TB, WH	28 ga	10'	25	20	500
GZF75ML	Galvanized 3/4" Z-Flashing	Mill	28 ga	10'	25	20	500



Z Flashing

Part No.	"A"	"B"
A/GZF38	3/8"	2-1/4"
A/GZF44	7/16"	2-1/8"
A/GZF50	1/2"	2-1/16"
A/GZF62	5/8"	2"
A/GZF75	3/4"	1-7/8"

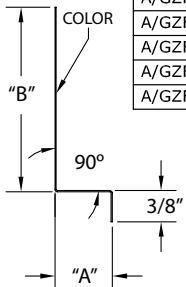

## Siding Accessories Colors | ● = Color-Thru System™

COLOR	CODE	COLOR	CODE	COLOR	CODE	COLOR	CODE	COLOR	CODE
● NX ALMOND	D49	● CHARCOAL GREY	CG	● HARBOR GREY	HG	PORTSMOUTH BLUE	XPB	● NX SIERRA CLAY	D47
● ALMOND	AL	● CLASSIC CREAM	CC	HAZEL WOOD	XHW	● REDWOOD	RW	● SILVER	SG
● BEAVER BROWN	BB	● COUNTRY BLUE	CU	● LINEN	LI	● ROYAL BROWN	RB	● NX TAN	D48
● BLACK	BK	● DESERT SAND	DS	● NX LINEN	W10	● NX RUSSET	B18	● TERRA BRONZE	TB
● BRONZE	BZ	EVEREST	EV	MONTANA SUEDE	XMS	SAGE	SA	● VICTORIAN GREY	VG
● BROOKSTONE	BS	● EVERGREEN	EG	● MUSKET BROWN	MB	● NX SAND	D51	VINTAGE BRICK	XVB
● BUCKSKIN	BU	● NX GRANITE	A19	● NORWEGIAN WOOD	NW	● NX SAND STONE	D46	● WHITE	WH
● CAMEO	CA			● PEBBLESTONE CLAY	PC	● SANDTONE	ST	● WICKER	WI
● NX CHAMPAGNE	D53								



# NORANDEX™ Siding Accessories

BELOIT PLANT

## Drip Cap

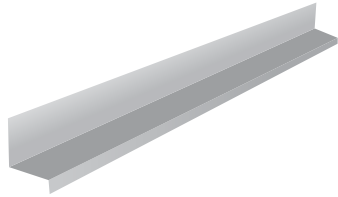

### 90° Drip Cap

#### Drip Cap 90°

Part No.	"A"	ALUM	GALV
		"B"	"B"
A/GDC078	7/8"	1-5/8"	1-5/8"
A/GDC100	1"	1-9/16"	1-9/16"
ADC118	1-1/8"	1-7/16"	1-7/16"
A/GDC125	1-1/4"	1-5/16"	1-5/16"
A/GDC138	1-3/8"	1-1/8"	1-1/8"
A/GDC150	1-1/2"	1-1/16"	1-1/16"
A/GDC158	1-5/8"	2-7/8"	2"
A/GDC175	1-3/4"	2-3/4"	1-7/8"
A/GDC200	2"	2-1/2"	1-5/8"

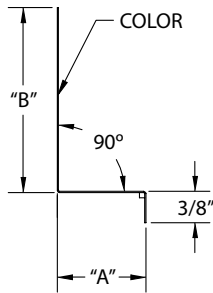

Part #	Description	Colors	Nom. Gauge/Thickness	Piece Length	Pieces/Box	Pieces/Pallet
ADC078 - -	Aluminum 7/8" Drip Cap 90°	(Listed Below)	0.019	10'	25	1125
ADC100 - -	Aluminum 1" Drip Cap 90°	(Listed Below)	0.019	10'	25	500
ADC100ML	Aluminum 1" Drip Cap 90°	Mill	0.019	10'	25	500
ADC118 - -	Aluminum 1-1/8" Drip Cap 90°	(Listed Below)	0.019	10'	25	500
ADC118ML	Aluminum 1-1/8" Drip Cap 90°	Mill	0.019	10'	25	500
ADC125 - -	Aluminum 1-1/4" Drip Cap 90°	(Listed Below)	0.019	10'	25	500
ADC125ML	Aluminum 1-1/4" Drip Cap 90°	Mill	0.019	10'	25	500
ADC138 - -	Aluminum 1-3/8" Drip Cap 90°	(Listed Below)	0.019	10'	25	500
ADC150 - -	Aluminum 1-1/2" Drip Cap 90°	(Listed Below)	0.019	10'	25	500
ADC150ML	Aluminum 1-1/2" Drip Cap 90°	Mill	0.019	10'	25	500
ADC158 - -	Aluminum 1-5/8" Drip Cap 90°	(Listed Below)	0.019	10'	25	500
ADC175 - -	Aluminum 1-3/4" Drip Cap 90°	(Listed Below)	0.019	10'	25	500
ADC175ML	Aluminum 1-3/4" Drip Cap 90°	Mill	0.019	10'	25	500
ADC200 - -	Aluminum 2" Drip Cap 90°	(Listed Below)	0.019	10'	25	500
GDC078ML	Galvanized 7/8" Drip Cap 90°	Mill	28 ga	10'	25	500
GDC100 - -	Galvanized 1" Drip Cap 90°	BK, RB, TB, WH	28 ga	10'	25	500
GDC100ML	Galvanized 1" Drip Cap 90°	Mill	28 ga	10'	25	500
GDC125ML	Galvanized 1-1/4" Drip Cap 90°	Mill	28 ga	10'	25	500
GDC138 - -	Galvanized 1-3/8" Drip Cap 90°	BK, TB, WH	28 ga	10'	25	500
GDC138ML	Galvanized 1-3/8" Drip Cap 90°	Mill	28 ga	10'	25	500
GDC150 - -	Galvanized 1-1/2" Drip Cap 90°	BK, RB, TB, WH	28 ga	10'	25	500
GDC150ML	Galvanized 1-1/2" Drip Cap 90°	Mill	28 ga	10'	25	500
GDC158 - -	Galvanized 1-5/8" Drip Cap 90°	BK, RB, TB, WH	28 ga	10'	25	500
GDC158ML	Galvanized 1-5/8" Drip Cap 90°	Mill	28 ga	10'	25	500
GDC175ML	Galvanized 1-3/4" Drip Cap 90°	Mill	28 ga	10'	25	500
GDC200 - -	Galvanized 2" Drip Cap 90°	BK, RB, TB	28 ga	10'	25	500
GDC200ML	Galvanized 2" Drip Cap 90°	Mill	28 ga	10'	25	500

### 95° Drip Cap

#### Drip Cap 95°

Part No.	"A"	"B"
A/GDC95118	1-1/8"	1-7/16"
A/GDC95125	1-1/4"	1-5/16"
A/GDC95200	2"	2-5/8"

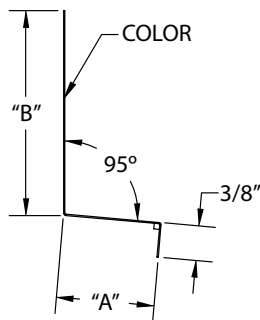

ADC95100 - -	Aluminum 1" Drip Cap 95°	(Listed Below)	0.019	10'	25	500
ADC95118 - -	Aluminum 1-1/8" Drip Cap 95°	(Listed Below)	0.019	10'	25	500
ADC95125 - -	Aluminum 1-1/4" Drip Cap 95°	(Listed Below)	0.019	10'	25	500
ADC95138 - -	Aluminum 1-3/8" Drip Cap 95°	(Listed Below)	0.019	10'	25	500
ADC95150 - -	Aluminum 1-1/2" Drip Cap 95°	(Listed Below)	0.019	10'	25	500
ADC95175 - -	Aluminum 1-3/4" Drip Cap 95°	(Listed Below)	0.019	10'	25	500
ADC95200 - -	Aluminum 2" Drip Cap 95°	(Listed Below)	0.019	10'	25	500

## Siding Accessories Colors | ● = Color-Thru System™

COLOR	CODE	COLOR	CODE	COLOR	CODE	COLOR	CODE
● NX ALMOND	D49	● CHARCOAL GREY	CG	● HARBOR GREY	HG	PORTSMOUTH BLUE	XPB
● ALMOND	AL	● CLASSIC CREAM	CC	● HAZEL WOOD	XHW	● REDWOOD	RW
● BEAVER BROWN	BB	● COUNTRY BLUE	CU	● LINEN	LI	● ROYAL BROWN	RB
● BLACK	BK	● DESERT SAND	DS	● NX LINEN	W10	● NX RUSSET	B18
● BRONZE	BZ	● EVEREST	EV	● MONTANA SUEDE	XMS	● SAGE	SA
● BROOKSTONE	BS	● EVERGREEN	EG	● MUSKET BROWN	MB	● NX SAND	D51
● BUCKSKIN	BU	● NX GRANITE	A19	● NORWEGIAN WOOD	NW	● NX SAND STONE	D46
● CAMEO	CA			● PEBBLESTONE CLAY	PC	● SANDTONE	ST
● NX CHAMPAGNE	D53					● NX SIERRA CLAY	D47
						● SILVER	SG
						● NX TAN	D48
						● TERRA BRONZE	TB
						● VICTORIAN GREY	VG
						● VINTAGE BRICK	XVB
						● WHITE	WH
						● WICKER	WI



## ALUMINUM LIMITED LIFETIME WARRANTY

# GUTTER SYSTEM PRODUCTS

Norandex manufactures Aluminum Gutter Coil and Gutter System Products in accordance with high standards and tight quality controls. The aluminum products will not rust, burn, support combustion, split, or crack due to cold weather.



### BUY NORANDEX GUTTER SYSTEM PRODUCTS WITH CONFIDENCE

#### KNOWING THAT:

- Norandex Aluminum Gutter System products carry a Limited Lifetime Warranty.
- Material and Labor is covered.
- Transferable at no charge.
- Doesn't require registration.

#### WHAT DOES THIS WARRANTY COVER?

Norandex warrants to the owner of the property at the time the products were installed, that the products are free from defects in material and workmanship in the course of manufacture, and that the finish on the products will not chip, peel, flake, or blister under conditions of ordinary wear if installed according to local building codes and industry specifications. This warranty is limited to the terms and conditions, exclusions and limitations, requirements and legal rights stated in this warranty.

#### HOW LONG DOES THE COVERAGE LAST?

If the property is individually owned, this Limited Lifetime Warranty lasts for the life of the property on which the products were originally applied for as long as the individual owns the property. If the property is not individually owned (e.g., corporation, condominium, cooperative housing arrangement, unincorporated association, school, church, government or public entity, etc.), the warranty period will be 50-years from the date of original installation of the products on the property, prorated as outlined in the Warranty Coverage Schedule contained within. This Limited Lifetime Warranty may be transferred with the property. However, upon the transfer, the warranty period will be no more than 50-years from the date of original installation of the products on the property, prorated in accordance with the Warranty Coverage Schedule contained within.

#### WHAT WILL NORANDEX DO?

Property owner must notify Norandex in accordance with the notice requirements outlined below to validate the complaint. In the event Norandex is denied access for an inspection, this warranty is null and void. Upon the notification and validation, Norandex will undertake the following: Norandex will repair, replace, or refund the purchase price of the defective portion of Norandex product that blisters, cracks, crazes, flakes, peels, or weathers unevenly due to a defect in the manufacturing process. Norandex obligations under this warranty will in no event exceed the purchase price of the originally installed products found to be warrantable and the cost of the labor involved in the original installation of such defective products. Any additional costs and expenses beyond these amounts are the property owner's responsibility. Norandex will not pay or be responsible for any costs associated with anything else affixed to the Norandex Metals product.

In the event of repair, replacement, or refinishing, the warranty will extend only for the time remaining under the original warranty. Norandex will determine the reasonable labor costs to repair, repaint, or replace product under this warranty.

#### WHAT IS NOT COVERED UNDER THE WARRANTY?

This warranty does not cover damage of any kind resulting from:

- Uninstalled product that is stored in situations where standing water is covering the surface for a prolonged period of times.
- Buckling or rippling of gutters.

- Faulty or improper contractor fabrication or installation, including "oil canning", waving, buckling, or other distortions.
- Installation of product in direct contact with dissimilar materials or salt spray.
- Cracking or crazing of the paint surface due to field forming of products in cold temperatures.
- Changes in surface color resulting from chalking, fading, soiling, tree sap, or staining. Exposure to the elements may cause these changes over time; the degree to which weathering occurs will vary depending on air quality, the building's location, and other local conditions over which Norandex has no control.
- Accidental damage.
- Settlement.
- Structural shrinkage or distortion of the property structure.
- Fire.
- Lightning, hurricane, tornado, windstorm, earthquake, hail, ice damage or other acts of God.
- Harmful chemicals including harmful cleaning compounds, herbicides, fertilizers, and pesticides.
- Fumes, volcanic smog, or vapors within 30-miles of volcano.
- Surface deterioration due to air pollution, use for animal confinement structures, or within a mile of seacoast and other bodies of saltwater.
- Misuse or abuse. Use of high pressure sprayers will void warranty.
- Vandalism;
- Airborne stains, mold and mildew accumulation.
- Tiger striping or atmospheric soil accumulation is a naturally occurring phenomenon that is not covered under the finish warranty.
- Failure of original or subsequent property owners to provide reasonable and necessary maintenance of the products (see "Care & Maintenance Instructions").
- Impact of foreign objects.
- Warping or distortion due to exposure to excessive heat sources (e.g., barbecue grills), or exposure to unusual or excessive reflective heat sources (e.g., window reflection).
- Products that have been painted, reinstalled, or whose surface has been altered in any way will void the paint finish warranty.
- Any other causes beyond Norandex reasonable control.

#### OTHER LIMITATIONS

1. This warranty covers only genuine Norandex Aluminum Gutter Coil and Gutter System products. It is the responsibility of the property owner to verify that the Gutter System products installed are Norandex products. Norandex products are warranted in the continental United States, Hawaii, and Alaska.
2. Gutter Coil is designed and intended for Gutter System applications and should not be used as roofing material or metal dome gutter protection due to esthetic reasons.
3. Due to normal weathering, replacement products may differ in gloss and color from products originally installed on the property.
4. Norandex reserve the right to discontinue or change any design or color of any products, at any time, and without notice or liability. If products of the type originally installed are no longer available, Norandex may substitute another product determined to be of comparable quality and price.

Continued on next page →

### ACM Customer Service

MW / NE - 877-279-5096

SE - 800-749-4067

SW - 800-357-7523

W - 877-213-5962

(Complete Aluminum Warranty available upon request)

NORANDEX™ PRODUCT CATALOG



## ALUMINUM LIMITED LIFETIME WARRANTY

# SIDING ACCESSORIES

Norandex manufactures Aluminum Siding Accessories which include Trim Coil, Soffit, Fascia, Soffit Channels, Drip Cap, and Z-Flashings, in accordance with high standards and tight quality controls. The aluminum products will not rust, burn, support combustion, split, or crack due to cold weather.



### BUY NORANDEX ALUMINUM SIDING ACCESSORIES WITH CONFIDENCE KNOWING THAT:

- Norandex aluminum siding accessories carry a Limited Lifetime Warranty.
- Material and Labor is covered.
- Transferable at no charge.
- Doesn't require registration.

### WHAT DOES THIS WARRANTY COVER?

Norandex warrants to the owner of the property at the time the products were installed, that the products are free from defects in material and workmanship in the course of manufacture, and that the finish on the products will not chip, peel, flake, or blister under conditions of ordinary wear if installed according to local building codes and industry specifications. This warranty is limited to the terms and conditions, exclusions and limitations, requirements, and legal rights stated in this warranty.

### HOW LONG DOES THE COVERAGE LAST?

If the property is individually owned, this Limited Lifetime Warranty lasts for the life of the property on which the products were originally applied for as long as the individual owns the property. If the property is not individually owned (e.g., corporation, condominium, cooperative housing arrangement, unincorporated association, school, church, government or public entity, etc.), the warranty period will be 50-years from the date of original installation of the products on the property, prorated as outlined in the Warranty Coverage Schedule contained within. This Limited Lifetime Warranty may be transferred with the property. However, upon the transfer, the warranty period will be no more than 50-years from the date of original installation of the products on the property, prorated in accordance with the Warranty Coverage Schedule contained within.

### WHAT WILL NORANDEX DO?

Property owner must notify Norandex in accordance with the notice requirements outlined below to validate the complaint. In the event Norandex is denied access for an inspection, this warranty is null and void. Upon the notification and validation, Norandex will undertake the following: Norandex will repair, replace, or refund the purchase price of the defective portion of Norandex product that blisters, cracks, crazes, flakes, peels, or weathers unevenly due to a defect in the manufacturing process. Norandex obligations under this warranty will in no event exceed the purchase price of the originally installed products found to be warrantable and the cost of the labor involved in the original installation of such defective products. Any additional costs and expenses beyond these amounts are the property owner's responsibility. Norandex will not pay or be responsible for any costs associated with anything else affixed to the Norandex product.

In the event of repair, replacement, or refinishing, the warranty will extend only for the time remaining under the original warranty. Norandex will determine the reasonable labor costs to repair, repaint, or replace product under this warranty.

### WHAT IS NOT COVERED UNDER THE WARRANTY?

This warranty does not cover damage of any kind resulting from:

- Uninstalled product that is stored in situations where standing water is covering the surface for a prolonged period of times.

- Faulty or improper contractor fabrication or installation, including waving, buckling, or other distortions.
- Installation of product in direct contact with dissimilar materials or salt spray.
- Cracking or crazing of the paint surface due to field forming of products in cold temperatures.
- Changes in surface color resulting from chalking, fading, soiling, tree sap, or staining. Exposure to the elements may cause these changes over time; the degree to which weathering occurs will vary depending on air quality, the building's location, and other local conditions over which Norandex has no control.
- Accidental damage.
- Settlement.
- Structural shrinkage or distortion of the property structure.
- Fire.
- Lightning, hurricane, tornado, windstorm, earthquake, hail, ice damage or other acts of God.
- Harmful chemicals including harmful cleaning compounds, herbicides, fertilizers, and pesticides.
- Fumes, volcanic smog, or vapors within 30-miles of volcano.
- Surface deterioration due to air pollution, use for animal confinement structures, or within a mile of seacoast and other bodies of saltwater.
- Misuse or abuse. Use of high pressure sprayers will void warranty.
- Vandalism.
- Airborne stains, mold and mildew accumulation.
- Tiger striping or atmospheric soil accumulation is a naturally occurring phenomenon that is not covered under the finish warranty.
- Failure of original or subsequent property owners to provide reasonable and necessary maintenance of the products (see "Care & Maintenance Instructions").
- Impact of foreign objects.
- Warping or distortion due to exposure to excessive heat sources (e.g., barbecue grills), or exposure to unusual or excessive reflective heat sources (e.g., window reflection).
- Products that have been painted, reinstalled, or whose surface has been altered in any way will void the paint finish warranty.
- Any other causes beyond Norandex reasonable control.

### OTHER LIMITATIONS

1. This warranty covers only genuine Norandex aluminum siding accessories. It is the responsibility of the property owner to verify that the siding accessories installed are Norandex products. Norandex products are warranted in the continental United States, Hawaii, and Alaska.
2. Oil canning is a natural occurring phenomenon on the surface of soffit panels and is associated with the milling of thinner gauge Aluminum. Norandex guarantees these spans with specific thickness to be free of oil canning:
  - .012 2-Foot Spans
  - .019 6-Foot Spans
3. Due to normal weathering, replacement products may differ in gloss and color from products originally installed on the property.
4. Norandex reserve the right to discontinue or change any design or color of any products, at any time, and without notice or liability. If products of the type originally installed are no longer available, Norandex may substitute another product determined to be of comparable quality and price.

Continued on next page →

### ACM Customer Service

MW / NE - 877-279-5096

SE - 800-749-4067

SW - 800-357-7523

W - 877-213-5962



## STEEL LIMITED LIFETIME WARRANTY GUTTER SYSTEM PRODUCTS

Norandex manufactures Steel Gutter System Products including gutter coil in accordance with high standards and tight quality controls. The products will not burn, support combustion, or split, or crack due to cold weather because they are made of steel.



### BUY NORANDEX STEEL GUTTER SYSTEM PRODUCTS WITH CONFIDENCE KNOWING THAT:

- Norandex Steel Gutter System products carry a Limited Lifetime Warranty.
- Material and Labor is covered.
- Doesn't require registration.

### WHAT DOES THIS WARRANTY COVER?

Norandex warrants to the owner of the property at the time the products were installed, that the products are free from defects in material and workmanship in the course of manufacture, and that the finish on the products will not chip, peel, flake, or blister under conditions of ordinary wear if installed according to local building codes and industry specifications. This warranty excludes any areas of the material that are within 3/4" of any edge that has been cut subsequent to the application of the paint to the substrate. This warranty is limited to the terms and conditions, exclusions and limitations, requirements, and legal rights stated in this warranty.

### HOW LONG DOES THE COVERAGE LAST?

If the property is individually owned, this Limited Lifetime Warranty lasts for the life of the property on which the products were originally applied for as long as the individual owns the property. If not individually owned (e.g., corporation, condominium, cooperative housing arrangement, unincorporated association, school, church, government or public entity, etc.), the warranty period will be 50-years from the date of original installation of the products on the property, prorated as outlined in the Warranty Coverage Schedule contained within. This Limited Lifetime Warranty is limited to the original owner. Coverage will be 100% for 10-years after the installation and prorated after that period. See Warranty Coverage Schedule section for details of prorated coverage.

### WHAT WILL NORANDEX DO?

Property owner must notify Norandex in accordance with the notice requirements outlined below to validate the complaint. In the event the manufacturer is denied access for an inspection, this warranty is null and void. Upon the notification and validation, Norandex will undertake the following: Norandex will repair, replace, or refund the purchase price of the defective portion of the product that blisters, cracks, crazes, flakes, peels, or weathers unevenly due to a defect in the manufacturing process. Norandex obligations under this warranty will in no event exceed the purchase price of the originally installed products found to be warrantable and the cost of the labor involved in the original installation of such defective products. Any additional costs and expenses beyond these amounts are the property owner's responsibility. Norandex will not pay or be responsible for any costs associated with anything else affixed to the Norandex product.

In the event of repair, replacement, or refinishing, the warranty will extend only for the time remaining under the original warranty. Norandex will determine the reasonable labor costs to repair, repaint, or replace product under this warranty.

### WHAT IS NOT COVERED UNDER THE WARRANTY?

This warranty does not cover damage of any kind resulting from:

- Product that is stored in situations where standing water is covering the surface for prolonged period of time.
- Faulty or improper installation, including "oil canning", waving, buckling, or other distortions.
- Installation of Norandex product in direct contact with dissimilar materials, salt spray, and cedar shake roofing.
- Cracking or crazing of the Product's paint surface due to field forming of products in cold temperatures; or material that has bends less than 2T for a sheet thickness of 0.0299" and thinner and bends less than 4T for a sheet thickness of 0.0300" and thicker.
- Changes in surface color resulting from chalking, fading, soiling, tree sap, or staining. Exposure to the elements may cause these changes over time; the degree to which weathering occurs will vary depending on air quality, the building's location, and other local conditions over which Norandex has no control.
- Accidental damage.
- Settlement.
- Structural shrinkage or distortion of the property structure.
- Fire.
- Lightning, hurricane, tornado, windstorm, earthquake, hail, ice damage or other acts of God.
- Harmful chemicals including harmful cleaning compounds, herbicides, fertilizers, and pesticides.
- Fumes, volcanic smog, or vapors within 30-miles of volcano.
- Surface deterioration due to air pollution, use for animal confinement structures, or within 1-mile of seacoast and other bodies of saltwater.
- Misuse or abuse. Use of high pressure sprayers will void warranty.
- Vandalism.
- Airborne stains, mold and mildew accumulation.
- Tiger striping or atmospheric soil accumulation is a naturally occurring phenomenon that is not covered under the finish warranty.
- Failure of original property owner to provide reasonable and necessary maintenance of the products (see "Care & Maintenance Instructions").
- Impact of foreign objects.
- Warping or distortion due to exposure to excessive heat sources (e.g., barbecue grills) or exposure to unusual or excessive reflective heat sources (e.g., window reflection).
- Products that have been painted, reinstalled, or whose surface has been altered in any way will void the paint finish warranty.
- Any other causes beyond Norandex reasonable control.

Continued on next page →

### ACM Customer Service

MW / NE - 877-279-5096

SE - 800-749-4067

SW - 800-357-7523

W - 877-213-5962

(Complete Steel Warranty available upon request)







# NORANDEX™

EXTERIOR PRODUCTS FOR YOUR HOME

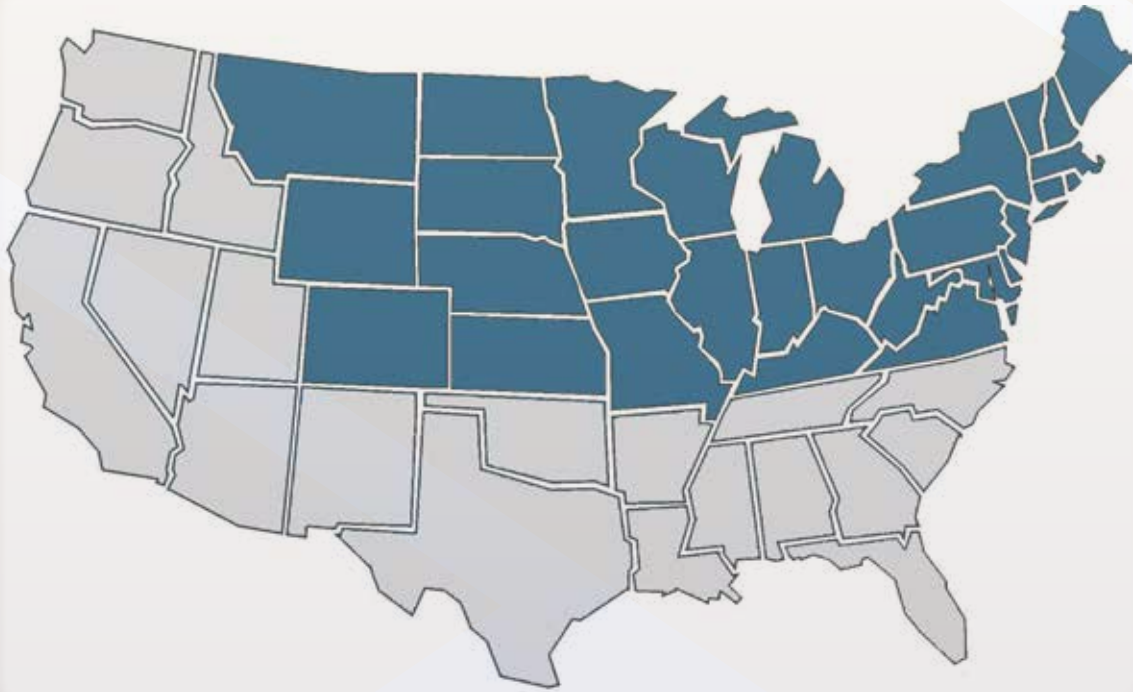

***Beloit Plant Serves Midwest & Northeast Regions***