

EDGE METALS



Apollo Beach Plant **PRODUCT CATALOG**

www.acm-metals.com

Apollo Beach Plant
EDGE METALS CATALOG

Table of Contents

Angle Flashing	2	Rain Diverter	10
Standard	2	Philly Flashing	10
No Kick	2	Counter Flashing	10
Drip Edge	3-7	Roll Valley	11
Professional (Closed Face)	3-4	W-Valley	11
Standard (Closed Face)	4	Roof to Wall Flashing	12
Roof Edge 90° with Kick	5	Sidewall Flashing	12
Professional (Open Face)	5	Flat Sheet	12
Professional (Open Face with Back)	6	Tile & Patio Accessories	13
F-8 Large (Open Face).....	6	Tile Ridge Cap Riser	13
Builders Alum. for Roof with 1/4" Overhang ..	6	Kick Plate Channel (Roll Form).....	13
Commercial for Roof with 1/4" Overhang...	7	Goosenecks	14
Premium Alum. for Roof with 1/4" Overhang..	7	Warranties	15-16
T Rake Edge	8		
Gravel Stop	8		
Gutter Apron 25°	8		
Pre-Bent Step Flashing	9		

PROUDLY FINISHED WITH
SHERWIN-WILLIAMS®
Coil Coatings

We reserve the right to change the content of product offerings at any time. Please consult the online catalog at www.acm-metals.com for the most update product offering.

Contact Information:

CUSTOMER SERVICE: Ph 800-749-4067 • Fax 608-364-0598
www.acm-metals.com



Angle Flashing

Part #	Description	Colors	Nom. Gauge/ Thickness	Piece Length	Pieces/ Box	Boxes/ Pallet	Pieces/ Pallet
Standard							
GAF25410ML	Galvanized 2-1/2 x 4 (C6) Ang. Flash.	Mill	26 ga	10'	10	35	350
GAF3310 - -	Galvanized 3 x 3 (C6) Ang. Flash.	AL, BK, RB, WH	26 ga	10'	10	35	350
GAF3310ML	Galvanized 3 x 3 (C6) Ang. Flash.	Mill	26 ga	10'	10	35	350
GAF4410 - -	Galvanized 4 x 4 (C7) Ang. Flash.	BK, RB, WH	26 ga	10'	10	35	350
GAF4410ML	Galvanized 4 x 4 (C7) Ang. Flash.	Mill	26 ga	10'	10	35	350

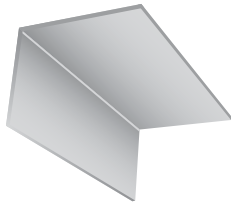
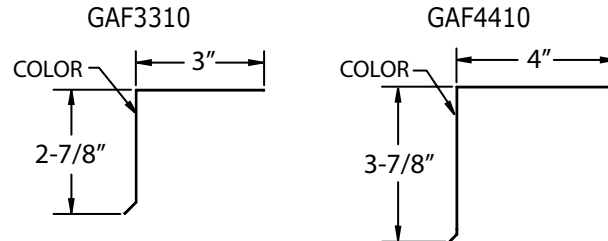
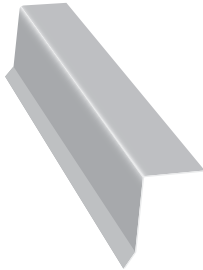
**No Kick (Color Outside)**

AAF2210WH	Aluminum 2 x 2 Angle Flashing	WH	0.019	10'	20	20	400
GAFN4410ML	Galvanized 4 x 4 Angle Flashing	Mill	26 ga	10'	10	35	350
LAF4510GL	Galvalume 4 x 5 Angle Flashing	Mill	26 ga	10'	20	20	400
LAF4610GL	Galvalume 4 x 6 Angle Flashing	Mill	26 ga	10'	20	20	400
LAF5510GL	Galvalume 5 x 5 Angle Flashing	Mill	26 ga	10'	20	20	400
LAF5710GL	Galvalume 5 x 7 Angle Flashing	Mill	26 ga	10'	20	20	400

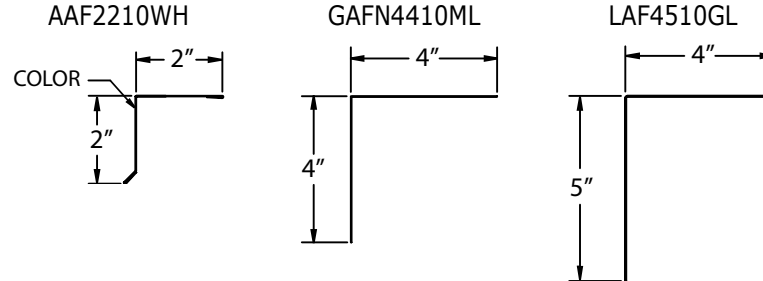
**ALUMINUM Colors:**

COLOR	CODE
WHITE	WH

STEEL Colors:

COLOR	CODE	COLOR	CODE	COLOR	CODE	COLOR	CODE
ALMOND	AL	BLACK	BK	ROYAL BROWN	RB	WHITE	WH

Drip Edge

Part #	Description	Colors	Nom. Gauge/ Thickness	Piece Length	Pieces/ Box	Boxes/ Pallet	Pieces/ Pallet
--------	-------------	--------	--------------------------	-----------------	----------------	------------------	-------------------

Professional - Closed Face

ADE10 - -	Aluminum 1" Face with 2-7/8" Back (F5)	BK, RB, WH	0.019	10'	50	24	1200
ADE15 - -	Aluminum 1-1/2" Face with 3" Back (F5)	AL, BK, BZ, MB, PC, RB, TB, VG, WH	0.019	10'	50	24	1200
ADE15ML	Aluminum 1-1/2" Face with 3" Back (F5)	Mill	0.019	10'	50	24	1200
ADE185 - -	Aluminum 1-3/4" Face with 2-5/8" Back	BK, BZ, MB, RB VG, WH WI	0.019	10'	50	24	1200
ADE185ML	Aluminum 1-3/4" Face with 2-5/8" Back	Mill	0.019	10'	50	24	1200
ADE2415WH	Aluminum 1-1/2" Face with 3" Back (F5)	WH	0.024	10'	25	24	600
ADE2420WH	Aluminum 2" Face with 3" Back (F5)	WH	0.024	10'	50	24	1200
GDE15WH	Galvanized 1-1/2" Face with 3" Back	WH	30 ga	10'	25	24	600
GDE15ML	Galvanized 1-1/2" Face with 3" Back	Mill	30 ga	10'	25	24	600
GDE822 - -	Galvanized 2" x 2" Dual Safety Hem 90°	RB, WH	28 ga	10'	10	68	680
GDE20 - -	Galvanized 2" Face (ODE) with 3" Back	RB, TB	28 ga	10'	25	24	600
GDE824 - -	Galvanized 2" x 4" Dual Safety Hem 90°	BK, RB, WH	28 ga	10'	10	40	400
GDE824ML	Galvanized 2" x 4" Dual Safety Hem 90°	Mill	28 ga	10'	10	40	400
CDE15	Copper 1-1/2" Face with 3" Back	Copper	16 oz	10'	10	48	480

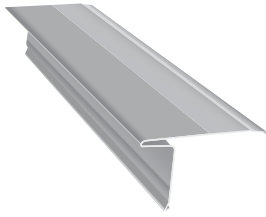

ADE10

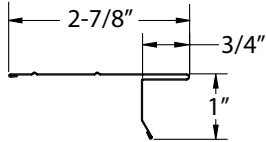

ADE15, GDE15, CDE15

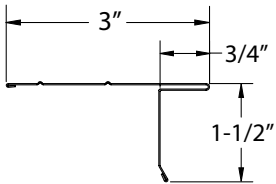

ADE185, ADE185ML

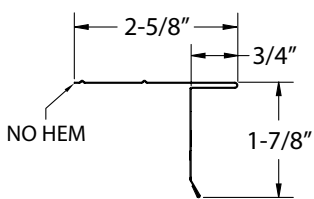

GDE822

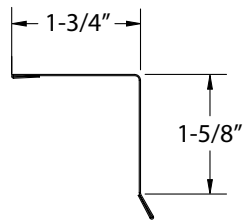

GDE20

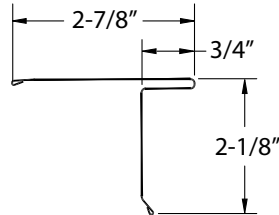

GDE824

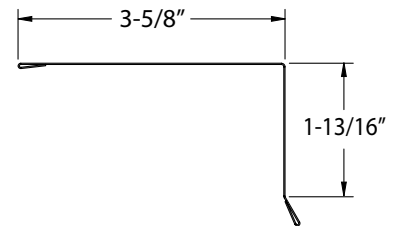

ADE2415

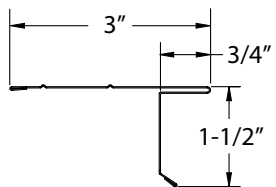

ALUMINUM Colors:

COLOR	CODE	COLOR	CODE	COLOR	CODE	COLOR	CODE
ALMOND	AL	MUSKET BROWN	MB	TERRA BRONZE	TB	WHITE	WH
BLACK	BK	PEBBLESTONE CLAY	PC	VICTORIAN GRAY	VG	WICKER	WI
BRONZE	BZ	ROYAL BROWN	RB				

STEEL Colors:

COLOR	CODE	COLOR	CODE	COLOR	CODE	COLOR	CODE
BLACK	BK	ROYAL BROWN	RB	TERRA BRONZE	TB	WHITE	WH

Drip Edge cont.

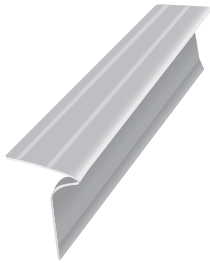

Part #	Description	Colors	Nom. Gauge/ Thickness	Piece Length	Pieces/ Box	Boxes/ Pallet	Pieces/ Pallet
Professional - Open Face							
LDE15 - -	Galvalume 1-1/2" Face	BK, RB, WH	26 ga	10'	25	20	500
LDE15ML	Galvalume 1-1/2" Face	Mill	26 ga	10'	25	20	500
LDE25 - -	Galvalume 2-7/8" Face	BK, BZ, CL, GY, RB, WH, WI	26 ga	10'	25	20	500
LDE25ML	Galvalume 2-1/2" Face	Mill	26 ga	10'	25	20	500
LDEEL25 - -	Galvalume 2-1/2" Face (Ext. Leg)	BK, RB, WH	26 ga	10'	25	20	500
TDE25WH	TPO 2-1/2" Face Drip Edge	WH	24 ga	10'	20/bundle		

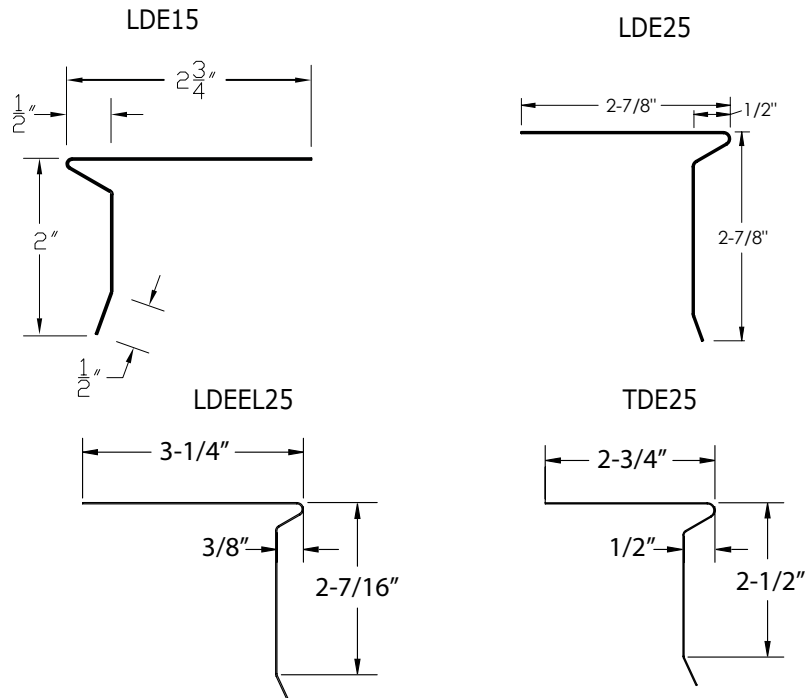

Standard - Closed Face

SADE15 - -	Aluminum 1-1/2" Face (F5M)	BK, RB, TB, WH	0.019	10'	50	24	1200
------------	----------------------------	----------------	-------	-----	----	----	------

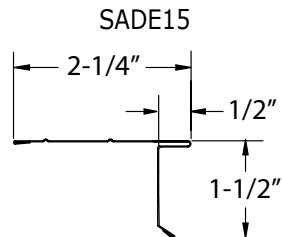

ALUMINUM Colors:

COLOR	CODE	COLOR	CODE	COLOR	CODE	COLOR	CODE
BLACK	BK	ROYAL BROWN	RB	TERRA BRONZE	TB	WHITE	WH

STEEL Colors:

COLOR	CODE	COLOR	CODE	COLOR	CODE	COLOR	CODE	COLOR	CODE
BLACK	BK	BRONZE BROWN	BZ BR	CLAY GRAY	CL GY	ROYAL BROWN	RB	WHITE WICKER	WH WI

Drip Edge cont.

Part #	Description	Colors	Nom. Gauge/ Thickness	Piece Length	Pieces/ Box	Boxes/ Pallet	Pieces/ Pallet
Roof Edge - 90° with a Kick							
LRE33 - -	Galvalume 3 x 3 Roof Edge w/Kick 90°	BK, RB , WH	26 ga	10'	25	20	500
LRE33ML	Galvalume 3 x 3 Roof Edge w/Kick 90°	Mill	26 ga	10'	25	20	500

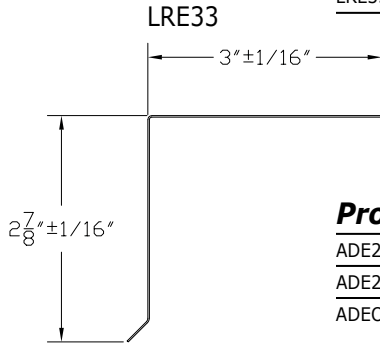

Professional - Open Face

ADE25 - -	Aluminum 2-3/4" Open Face	RB, WH	0.025	10'	25	20	500
ADE2545WH	Aluminum 4-1/2" Open Face	WH	0.025	10'	25	20	500
ADEOF275	Aluminum 2-3/4" Open Face	BK	0.019	10'	25	20	500

ADE25 - -, ADEOF275

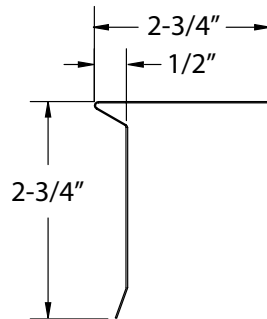

ADE2545

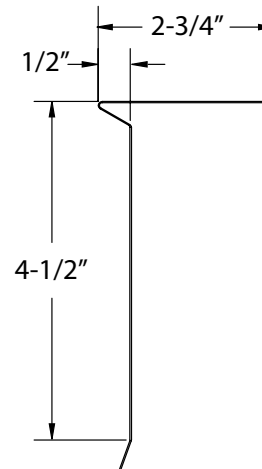

ALUMINUM Colors:

COLOR	CODE
WHITE	WH

STEEL Colors:

COLOR	CODE	COLOR	CODE	COLOR	CODE
BLACK	BK	BROWN	BR	WHITE	WH

Drip Edge cont.

Part #	Description	Colors	Nom. Gauge/ Thickness	Piece Length	Pieces/ Box	Boxes/ Pallet	Pieces/ Pallet
Professional - Open Face with Back							
ADEOF10 - -	Alum. 1-1/2" Open Face w/3-3/4" Back (F5-1/20) BK, RB, TB, WH		0.019	10'	50	24	1200
ADEOF10ML	Alum. 1-1/2" Open Face w/3-3/4 Back (F5-1/20)	Mill	0.019	10'	50	24	1200

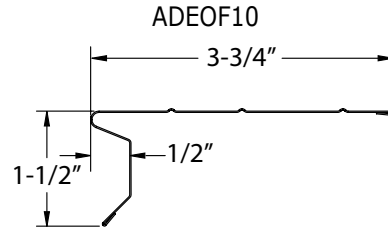
**F-8 Large - Open Face**

ADEF8 - -	Aluminum 1-1/2" Open Face w/5-3/4" Back (F8)BK, RB, TB, WH		0.019	10'	25	24	600
-----------	--	--	-------	-----	----	----	-----

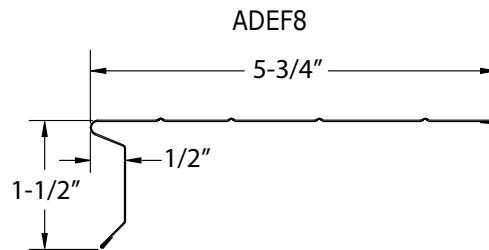
**ALUMINUM Colors:**

COLOR	CODE	COLOR	CODE	COLOR	CODE	COLOR	CODE
BLACK	BK	ROYAL BROWN	RB	TERRA BRONZE	TB	WHITE	WH

STEEL Colors:

COLOR	CODE	COLOR	CODE	COLOR	CODE
BLACK	BK	ROYAL BROWN	RB	WHITE	WH

Drip Edge *cont.*

Part #	Description	Colors	Nom. Gauge/ Thickness	Piece Length	Pieces/ Box	Boxes/ Pallet	Pieces/ Pallet
Commercial Aluminum for Roof with 1/4" Overhang							
ADEC17 - -	Alum. 1-3/4" Face w/Hem	WH	0.019	10'	50	24	1200
ADEC20WH	Aluminum 2" Face w/Hem	WH	0.019	10'	50	24	1200
ADEC25 - -	Aluminum 2-1/2" Face w/Hem	WH	0.019	10'	50	24	1200
ADEWC17 - -	Alum. 1-3/4" Face Wood Grain w/Hem	AL, AI, BK, BZ, CG, MB, RB, WH	0.019	10'	50	24	1200
ADEWC25 - -	Alum. 2-1/2" Face Wood Grain w/Hem	WH	0.019	10'	50	24	1200

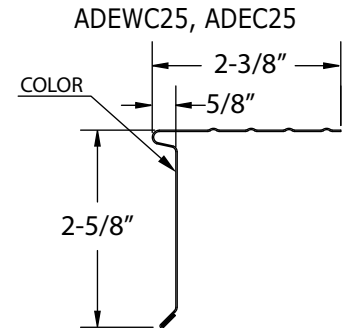
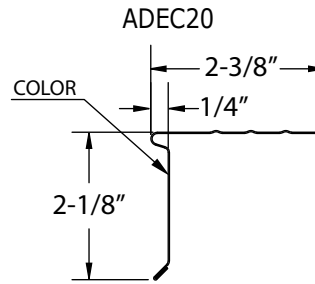
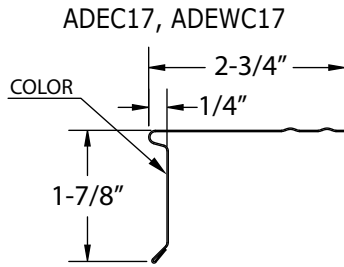

Commercial Aluminum Drip Edge Colors:

COLOR	CODE	COLOR	CODE	COLOR	CODE	COLOR	CODE
ALMOND	AL	BLACK	BK	CHARCOAL GRAY	CG	ROYAL BROWN	RB
ANTIQUÉ IVORY	AI	BRONZE	BZ	MUSKET BROWN	MB	WHITE	WH

Premium Aluminum for Roof with 1/4" Overhang

ADED17WH	Alum. 1-3/4" Face w/Hem	WH	0.024	10'	50	24	1200
ADED20WH	Alum. 2" Face w/Hem	WH	0.024	10'	50	24	1200
ADED25 - -	Alum. 2-1/2" Face w/Hem	WH	0.024	10'	50	24	1200
ADEWD17 - -	Alum. 1-3/4" Face Wood Grain w/Hem	WH	0.024	10'	50	24	1200
ADEWD20 - -	Alum. 2" Face Wood Grain w/Hem	WH	0.024	10'	50	24	1200

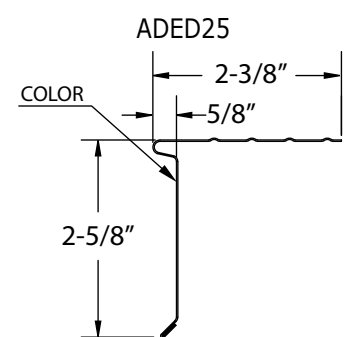
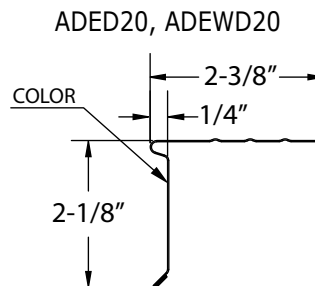
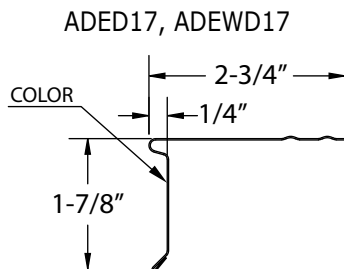

Premium Aluminum Color:

COLOR	CODE
WHITE	WH

T Rake Edge

Part #	Description	Colors	Nom. Gauge/ Thickness	Piece Length	Pieces/ Box	Boxes/ Pallet	Boxes/ Pallet
GTRE175--	Galvanized 1-7/8" Face with 2-7/8" Back DE	BK, RB, TB, WH	28 ga	10'	10	10	35

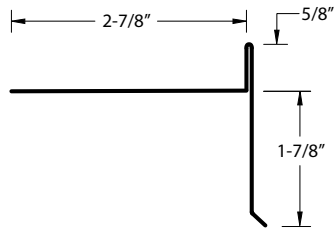

Can be used with F-Wave™ or Asphalt Shingles

Gravel Stop

Part #	Description	Colors	Nom. Gauge/ Thickness	Piece Length	Pieces/ Box	Boxes/ Pallet	Pieces/ Pallet
GG30ML	Galv. 3" Face (H6F) Gravel Stop	Mill	24 ga	10'	10	35	350
GG40ML	Galv. 4" Face (H6F) Gravel Stop	Mill	24 ga	10'	10	35	350

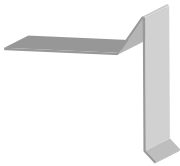

GG30ML, GGS40ML

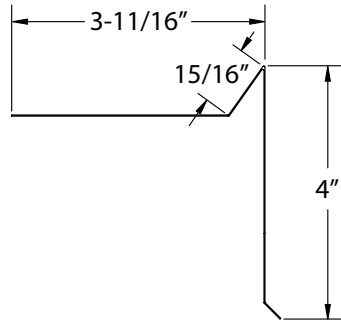
**Gutter Apron 25°**

Part #	Description	Color	Nom. Gauge/ Thickness	Piece Length	Pieces/ Box	Pieces/ Bundle	Boxes/ Pallet	Pieces/ Pallet
AGA20 --	Aluminum 2" Face	BK, RB, WH	0.019	10'	50		32	1600

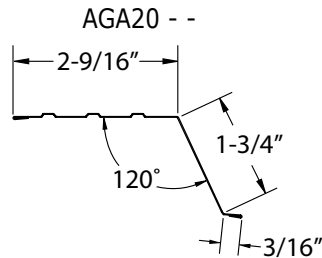
**ALUMINUM Colors:**

COLOR	CODE	COLOR	CODE	COLOR	CODE
BLACK	BK	ROYAL BROWN	RB	WHITE	WH

Pre-Bent Step Flashing

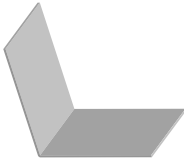

Part #	Description	Color	Nom. Gauge/ Thickness	Piece Length	Pieces/ Bundle	Pieces/ Box
APSF237 - -	Aluminum 2 x 3 x 7 PB Step Flashing	BK, RB	0.011	7"	100	500
APSF237ML	Aluminum 2 x 3 x 7 PB Step Flashing	Mill	0.011	7"	100	500
APSF57 - -	Aluminum 2-1/2 x 2-1/2 x 7 PB Step Flash.	BK, RB	0.011	7"	100	500
APSF57ML	Aluminum 2-1/2 x 2-1/2 x 7 PB Step Flash.	Mill	0.011	7"	100	500
APSF347 - -	Aluminum 3 x 4 x 7 PB Step Flashing	BK, RB, TB	0.011	7"	100	500
APSF347ML	Aluminum 3 x 4 x 7 PB Step Flashing	Mill	0.011	7"	100	500
APSF557BK	Aluminum 5 x 5 x 7 PB Step Flashing	BK	0.011	7"	100	500
APSF558BK	Aluminum 5 x 5 x 8 PB Step Flashing	BK	0.011	8"	100	500
APSF5585 - -	Aluminum 5 x 5 x 8 PB Step Flashing	BK, RB	0.011	8"	50	250
APSF5585ML	Aluminum 5 x 5 x 8 PB Step Flashing	Mill	0.011	8"	50	250
APSF2885BK	Aluminum 4 x 4 x 8 PB Step Flashing	BK	0.024	8"	50	250
APSF88 - -	Aluminum 4 x 4 x 8 PB Step Flashing	BK, RB, TB	0.011	8"	100	500
APSF88ML	Aluminum 4 x 4 x 8 PB Step Flashing	Mill	0.011	8"	100	500
<hr/>						
GPSF347ML	Galvanized 3 x 4 x 7 PB Step Flashing	Mill	30 ga	7"	100	
GPSF57ML	Galvanized 2-1/2 x 2-1/2 x 7 PB Step Flash.	Mill	28 ga	7"	100	
GPSF88ML	Galvanized 4 x 4 x 8 PB Step Flashing	Mill	30 ga	8"	100	
<hr/>						
LPSF457ML	Galvalume 4 x 5 x 7 PB Step Flashing	Mill	26 ga	7"	25	
<hr/>						
CPSF57	Copper 2-1/2 x 2-1/2 x 7 PB Step Flash.	Copper	16 oz	7"	Order by the pc.	
CPSF88	Copper 4 x 4 x 8 PB Step Flashing	Copper	16 oz	8"	Order by the pc.	
CPSF914	Copper 4-1/2 x 4-1/2 x 14 PB Step Flash.	Copper	16 oz	14"	Order by the pc.	

APSF237

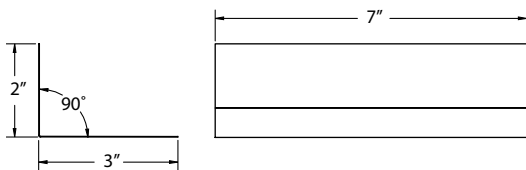

APSF57, GPSF57, CPSF57

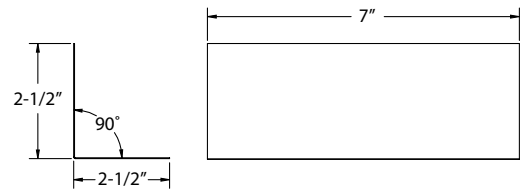

APSF347, GPSF347

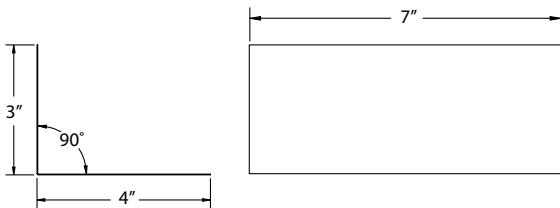

APSF88, GPSF88, CPSF88

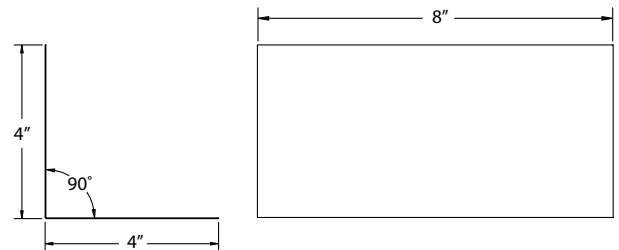

APSF557

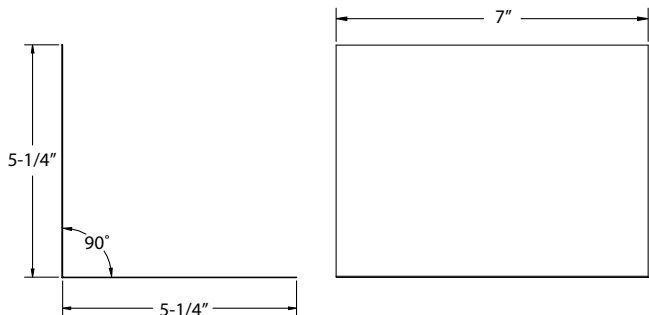

APSF558

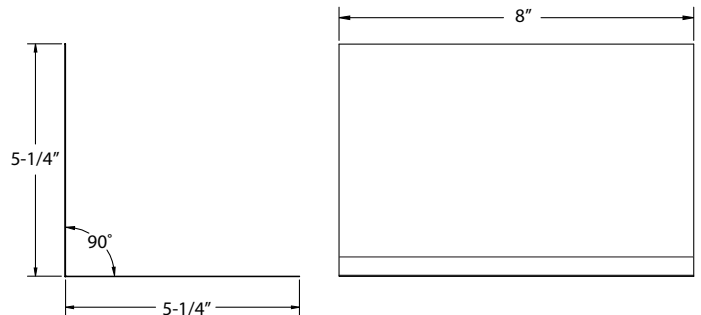

ALUMINUM Colors:

COLOR	CODE	COLOR	CODE	COLOR	CODE
BLACK	BK	ROYAL BROWN	RB	TERRA BRONZE	TB

Rain Diverter

Part #	Description	Colors	Nom. Gauge/ Thickness	Piece Length	Pieces/ Box	Boxes/ Pallet	Pieces/ Pallet
GRD710 - -	Galvanized 7" Rain Diverter	BK, RB	26 ga	10'	10	25	250
GRD710ML	Galvanized 7" Rain Diverter	Mill	26 ga	10'	10	25	250

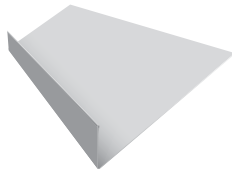

GRD710

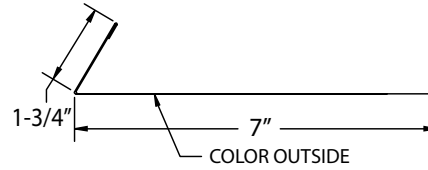

Philly Flashing

Part #	Description	Colors	Nom. Gauge/ Thickness	Piece Length	Pieces/ Box	Boxes/ Pallet	Pieces/ Pallet
LPHF310ML	Galvalume 3" Philly Flashing	Mill	26 ga	10'	20	20	400

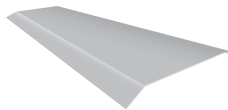

Counter Flashing

Part #	Description	Color	Nom. Gauge/ Thickness	Piece Length	Pieces/ Box	Boxes/ Pallet	Pieces/ Pallet
GCF64BK	Galvanized 4" Counter Flashing	BK	26 ga	10'	10	25	250
GCF66BK	Galvanized 6" Counter Flashing	BK	26 ga	10'	10	25	250

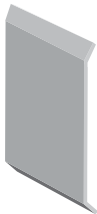

GCF64BK

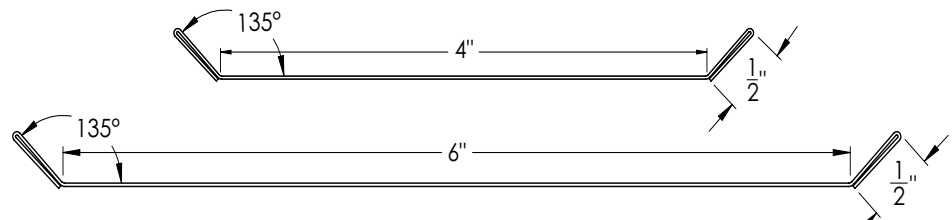

GCF66BK

STEEL Colors:

COLOR	CODE	COLOR	CODE	COLOR	CODE	COLOR	CODE
ALMOND	AL	BLACK	BK	ROYAL BROWN	RB	TERRA BRONZE	TB

Roll Valley



Part #	Description	Colors	Nom. Gauge/ Thickness	Piece Length	Pieces/ Box	Boxes/ Pallet	Pieces/ Pallet
ARV10ML	Aluminum 10" Roll Valley	Mill	0.011	50'	1	25	25
ARV12ML	Aluminum 12" Roll Valley	Mill	0.011	50'	1	25	25
ARV14ML	Aluminum 14" Roll Valley	Mill	0.011	50'	1	25	25
ARV20ML	Aluminum 20" Roll Valley	Mill	0.011	50'	1	25	25
GRV26205ML	Galvanized 20" Roll Valley	Mill	26 ga	50'	1	50	50
GRV8ML	Galvanized 8" Roll Valley	Mill	32 ga	50'	1	25	25
GRV10ML	Galvanized 10" Roll Valley	Mill	32 ga	50'	1	25	25
GRV12ML	Galvanized 12" Roll Valley	Mill	32 ga	50'	1	25	25
GRV14ML	Galvanized 14" Roll Valley	Mill	32 ga	50'	1	25	25
GRV20ML	Galvanized 20" Roll Valley	Mill	32 ga	50'	1	25	25
GRV24ML	Galvanized 24" Roll Valley	Mill	32 ga	50'	1	25	25
LRV26165GL	Galvalume 16" Roll Valley	Mill	26 ga	50'	1	50	50
CRV112	Copper 12" Roll Valley 100 lb	Copper	16 oz	100'	Order by the pc.		
CRV116	Copper 16" Roll Valley 80 lb	Copper	16 oz	60'	Order by the pc.		
CRV120	Copper 20" Roll Valley 100 lb	Copper	16 oz	60'	Order by the pc.		
CRV124	Copper 24" Roll Valley 100 lb	Copper	16 oz	50'	Order by the pc.		

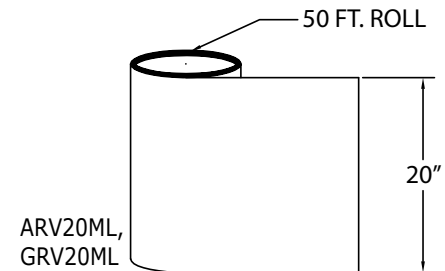
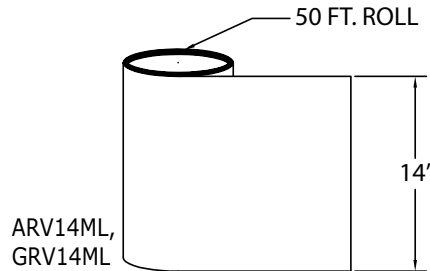
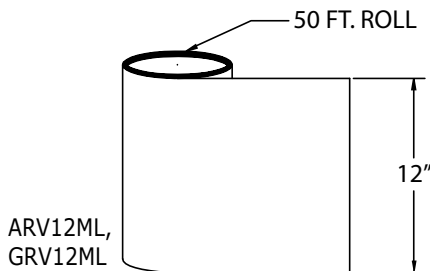

W-Valley



Part #	Description	Colors	Nom. Gauge/ Thickness	Piece Length	Pieces/ Bundle	Pieces/ Pallet
AWV24 - -	Aluminum 24" W-Valley	BK, BZ, RB, TB	0.019	10'	100	100
GPV2618ML	Galvanized 18" Preformed W-Valley	Mill	26 ga	10'	Order by the pc.	
GWV2620 - -	Galvanized 20" W-Valley	BK, RB, TB	26 ga	10'	100	100
GWV18 - -	Galvanized 18" W-Valley	BK, RB, TB	30 ga	10'	100	100
GWV20TB	Galvanized 20" W-Valley	TB	30 ga	10'	100	100
LTV24ML	Galvalume 24" Tile Valley	Mill	26 ga	10'	25	200
LTVH24ML	Galvalume 24" Tile Valley w/Hem	Mill	26 ga	10'	25	100
CWV18	Copper 18" W-Valley	Copper	16 oz	10'	10	100
CWV24	Copper 24" W-Valley	Copper	16 oz	10'	10	100

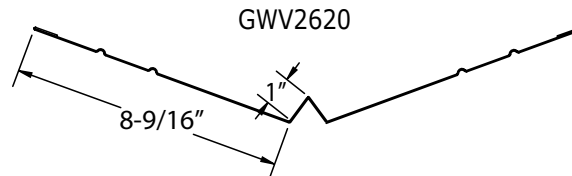

ALUMINUM Colors:

COLOR	CODE	COLOR	CODE	COLOR	CODE	COLOR	CODE
BLACK	BK	BRONZE	BZ	ROYAL BROWN	RB	TERRA BRONZE	TB

STEEL Colors:

COLOR	CODE	COLOR	CODE	COLOR	CODE	COLOR	CODE
BLACK	BK	BROWN	BR	ROYAL BROWN	RB	TERRA BRONZE	TB

Roof to Wall Flashing

Part #	Description	Colors	Nom. Gauge/ Thickness	Piece Length	Pieces/ Box	Boxes/ Pallet	Pieces/ Pallet
ARTW4410 - -	Aluminum 4 x 4 R/W Flashing	BK, TB	0.019	10'	25	25	625
LTRWFML	Galvalume 5 x 6 Tile R/W Flashing	Mill	26 ga	10'	10	10	100

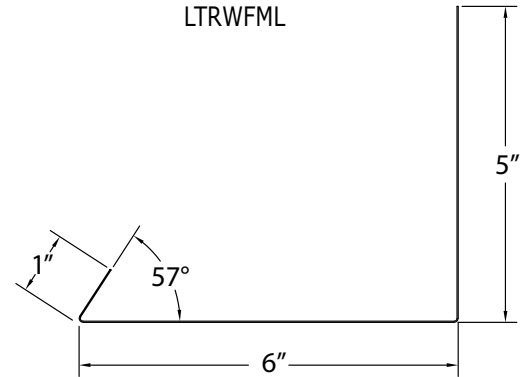
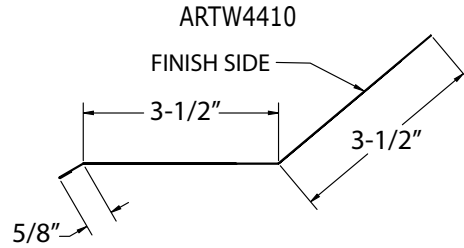
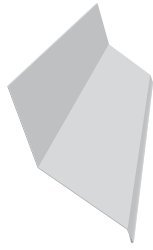

Sidewall Flashing

Part #	Description	Colors	Nom. Gauge/ Thickness	Piece Length	Pieces/ Box	Boxes/ Pallet	Pieces/ Pallet
ASWF4410TB	Alum. 4 x 4 x 10 Side Wall Flashing	TB	0.019	10'	10	14	140
GSWF4410ML	Galv. 4 x 4 x 10 Side Wall Flashing	Mill	26 ga	10'	10	35	350

ASWF4410, GSWF4410

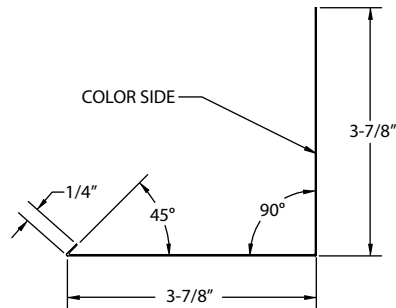

Flat Sheet

Part #	Description	Colors	Nom. Gauge/ Thickness	Piece Length	Pieces/ Box	Pieces/ Pallet
CFS3610	Copper 36" x 10' Flat Sheet	Copper	16 oz	10'	Order by the pc.	65

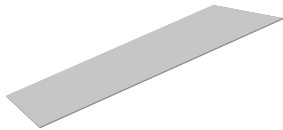

ALUMINUM Colors:

COLOR	CODE	COLOR	CODE
BLACK	BK	TERRA BRONZE	TB

STEEL Colors:

COLOR	CODE	COLOR	CODE	COLOR	CODE	COLOR	CODE
BLACK	BK	ROYAL BROWN	RB	TERRA BRONZE	TB	WHITE	WH

Tile Ridge Cap Riser

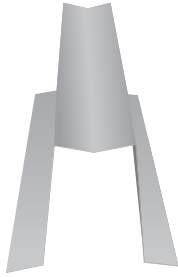

Part #	Description	Colors	Nom. Gauge/ Thickness	Piece Length	Pieces/ Bundle	Pieces/ Pallet
LRCR3ML	Galvalume 3" Tile Ridge Cap Riser	Mill	26 ga	10'	15	75
LRCR4ML	Galvalume 4" Tile Ridge Cap Riser	Mill	26 ga	10'	15	75
LRCR5ML	Galvalume 5" Tile Ridge Cap Riser	Mill	26 ga	10'	15	75
LRCR6ML	Galvalume 6" Tile Ridge Cap Riser	Mill	26 ga	10'	15	75

**Kick Plate Channel
(Roll Form)**

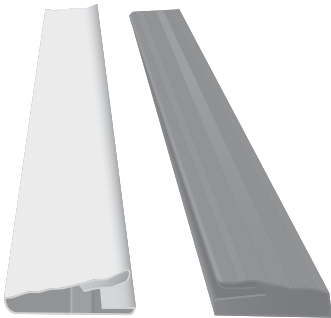

Part #	Description	Colors	Nom. Gauge/ Thickness	Piece Length	Pieces/ Bundle
AKP10 - -	Aluminum 10' Kick Plate Channel	TBZ, T80	0.024	10'	25
AKP12 - -	Aluminum 12' Kick Plate Channel	TBZ, T80	0.024	12'	25

Aluminum Patio Accessories Colors:

COLOR	CODE	COLOR	CODE	COLOR	CODE
TAMPA BRONZE	TBZ	TAMPA 80 WHITE	T80	WHITE	WH

Goosenecks

Part #	Description	Colors	Nom. Gauge/ Thickness	Pieces Per Box	Pieces Per Pallet
LGND10 - -	GLUM Gooseneck 10" Shingle w/Damper	BK, RB, WH	26 ga	6	48
LGND10ML	GLUM Gooseneck 10" Shingle w/Damper	MILL	26 ga	6	48
LGNTD10ML	GLUM Gooseneck 10" Tile w/Damper	MILL	26 ga	6	36
LGND6 - -	GLUM Gooseneck 6" Shingle w/Damper	BK, RB, WH	26 ga	18	72
LGND6ML	GLUM Gooseneck 6" Shingle w/Damper	MILL	26 ga	18	72
LGNTD6ML	GLUM Gooseneck 6" Tile w/Damper	MILL	26 ga	18	72
LGND4 - -	GLUM Gooseneck 4" Shingle w/Damper	BK, RB, WH	26 ga	20	220
LGND4ML	GLUM Gooseneck 4" Shingle w/Damper	MILL	26 ga	20	220
LGNTD4ML	GLUM Gooseneck 4" Tile w/Damper	MILL	26 ga	20	160

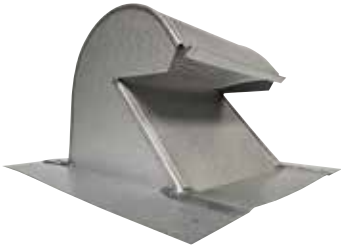

DESIGNED FOR HIGH AIRFLOW

For use on all residential steep slope roofs • Made of 26 ga. galvalume metal

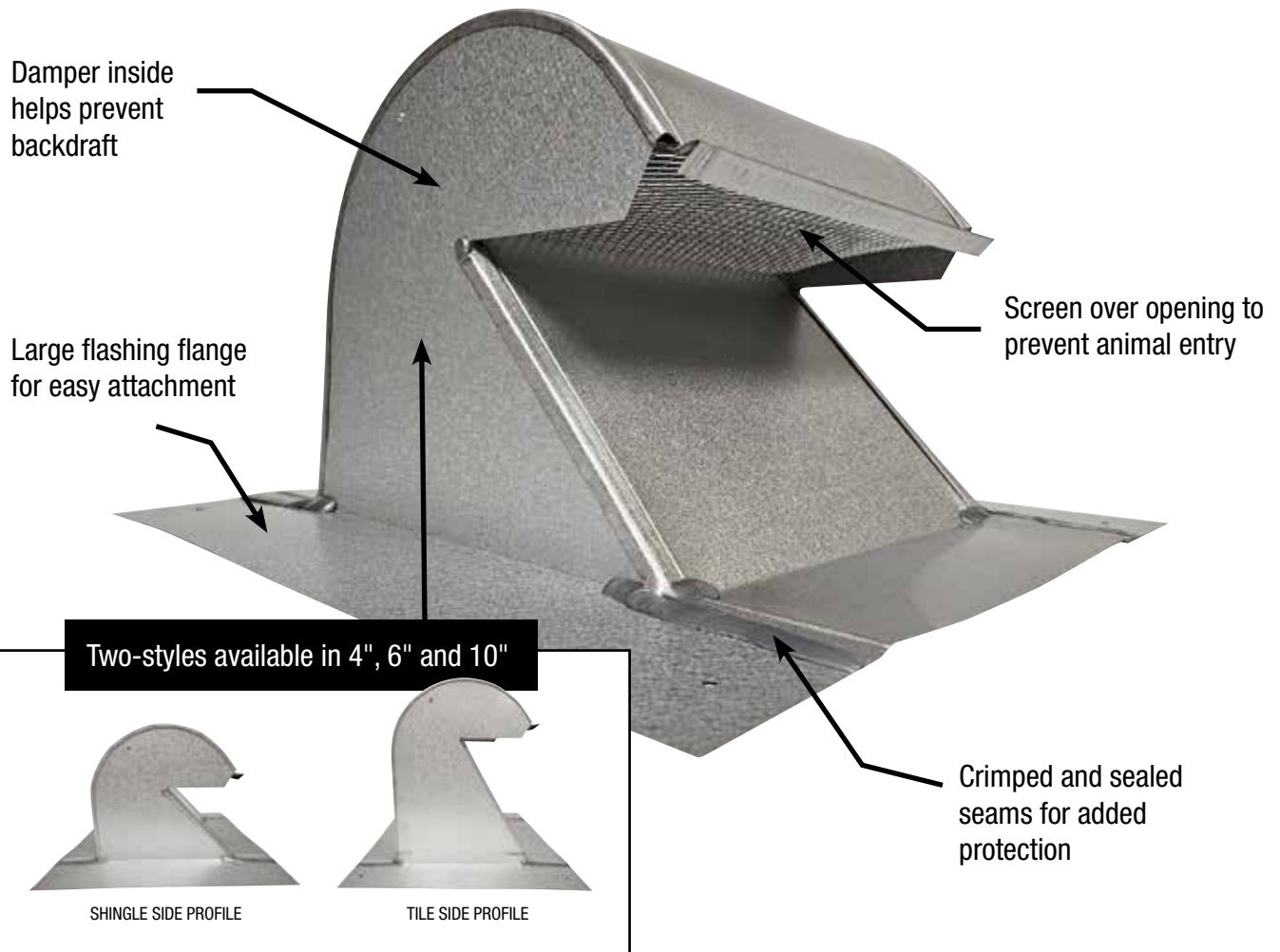

Gooseneck Colors:

COLOR	CODE	COLOR	CODE	COLOR	CODE	COLOR	CODE
BLACK	BK	MILL	ML	ROYAL BROWN	RB	WHITE	WH



ALUMINUM LIMITED LIFETIME WARRANTY

EDGE METAL PRODUCTS

American Construction Metals (ACM), manufactures Aluminum Edge Metal Products in accordance with high standards and tight quality controls. Products covered in this warranty include Drip Edge, W-Valleys, and other Roof Flashings. The aluminum products will not burn, support combustion, split, or crack due to cold weather.



BUY ACM PRODUCTS WITH CONFIDENCE KNOWING THAT:

- ACM Aluminum Edge Metal products carry a Limited Lifetime Warranty.
- Material and Labor is covered.
- Doesn't require registration.

WHAT DOES THIS WARRANTY COVER?

ACM warrants to the owner of the property at the time the products were installed, that the products were free from defects in material and workmanship in the course of manufacture, and that the finish on the products will not chip, peel, flake, or blister under conditions of ordinary wear. Products must be installed according to local building codes and industry specifications. This warranty excludes any areas of the material that are within 3/4" of any edge that has been cut subsequent to the application of the paint to the substrate. This warranty is limited to the terms and conditions, exclusions, limitations, requirements, and legal rights stated in this warranty.

HOW LONG DOES THE COVERAGE LAST?

If the property is individually owned, this Limited Lifetime Warranty lasts for the life of the property on which the products were originally applied for as long as the individual owns the property. If the property is not individually owned (e.g. corporation, condominium, cooperative housing arrangement, unincorporated association, school, church, government, or public entity, etc.), the warranty period will be 50-years from the date of original installation of the products on the property, prorated as outlined in the Warranty Coverage Schedule contained within. This Limited Lifetime Warranty is limited to the original owner. Coverage will be 100% for ten years after the installation and prorated after that period. See Warranty Coverage Schedule section for details of prorated coverage.

WHAT WILL ACM DO?

Property owner must notify the ACM Warranty Department in accordance with the notice requirements outlined below to validate the complaint. In the event the manufacturer is denied access for an inspection, this warranty is null and void. Upon the notification and validation, ACM will undertake the following: ACM will repair, repaint, replace, or refund the purchase price of the defective portion of ACM product that blisters, cracks, crazes, flakes, peels, or weathers unevenly due to a defect in the manufacturing process. ACM's obligations under this warranty will in no event exceed the purchase price of the originally installed products found to be warrantable in the original installation of such defective products. Any additional costs and expenses beyond these amounts are the property owner's responsibility. ACM will not pay or be responsible for any costs associated with or related to anything else affixed to the material or building's roof, including but not limited to solar panels, television antennas, moisture sensors, etc.

In the event of repair, replacement, or refinishing, the warranty will extend only for the time remaining under the original warranty. ACM will determine the reasonable labor costs to repair, repaint, or replace product under this warranty.

WHAT IS NOT COVERED UNDER THE WARRANTY?

This warranty does not cover damage of any kind resulting from:

- Uninstalled product that is stored in situations where standing water is covering the surface for a prolonged period of time.
- Faulty or improper installation, including "oil canning", waving, buckling, or other distortions. Flat roof or commercial applications require minimum of .050" aluminum material.
- Installation of ACM product in direct contact with dissimilar materials, salt spray, and cedar shake roofing.
- Cracking or crazing of the product's paint surface due to field forming of products in cold temperatures; or material that has bends less than 2T for a sheet thickness of 0.0299" and thinner and bends less than 4T for a sheet thickness of 0.0300" and thicker.
- Changes in surface color resulting from chalking, fading, soiling, tree sap, or staining. Exposure to the elements may cause these changes over time. The degree to which weathering occurs will vary depending on air quality, the building's location, and other local conditions over which ACM has no control.
- Accidental damage.
- Settlement.
- Structural shrinkage or distortion of the property structure.
- Fire.
- Lightning, hurricane, tornado, windstorm, earthquake, hail, ice damage or other acts of God.
- Issues stemming from ice damming and the common remedies including the use of ice rakes, salt or deicing chemicals, and high pressure steam spraying.
- Harmful chemicals including cleaning compounds, herbicides, and pesticides.
- Fumes, volcanic smog, or vapors within 30-miles of volcano.
- Surface deterioration due to air pollution, use for animal confinement structures, or within a mile of the seacoast and other bodies of saltwater.
- Misuse or abuse. Use of high pressure sprayer will void warranty.
- Vandalism.
- Airborne stains, mold and mildew accumulation.
- Tiger striping or atmospheric soil accumulation is a naturally occurring phenomenon that is not covered under the finish warranty.
- Failure of original property owners to provide reasonable and necessary maintenance of the products.
- Impact of foreign objects.
- Warping or distortion due to exposure to excessive heat sources.
- Products that have been painted, reinstalled, or whose surface has been altered in any manner will void the warranty.
- Any other causes beyond the reasonable control of ACM.

Continued on next page →

ACM Customer Service

MW / NE - 877-279-5096

SE - 800-749-4067

SW - 800-357-7523

W - 877-213-5962



STEEL LIMITED LIFETIME WARRANTY EDGE METAL PRODUCTS

American Construction Metals (ACM), manufactures Steel Edge Metal Products in accordance with high standards and tight quality controls. Products covered in this warranty include Drip Edge, W-Valleys, and other Roof Flashings. The steel products will not burn, support combustion, split, or crack due to cold weather.



BUY ACM PRODUCTS WITH CONFIDENCE KNOWING THAT:

- ACM steel edge metal products carry a Limited Lifetime Warranty.
- Material and labor is covered.
- Doesn't require registration.

WHAT DOES THIS WARRANTY COVER?

ACM warrants to the owner of the property at the time the products were installed, that the products were free from defects in material and workmanship in the course of manufacture, and that the finish on the products will not chip, peel, flake, or blister under conditions of ordinary wear. Products must be installed according to local building codes and industry specifications. This warranty excludes any areas of the material that are within 3/4" of any edge that has been cut subsequent to the application of the paint to the substrate. This warranty is limited to the terms and conditions, exclusions, limitations, requirements, and legal rights stated in this warranty.

HOW LONG DOES THE COVERAGE LAST?

If the property is individually owned, this Limited Lifetime Warranty lasts for the life of the property on which the products were originally applied for as long as the individual owns the property. If the property is not individually owned (e.g. corporation, condominium, cooperative housing arrangement, unincorporated association, school, church, government, or public entity, etc.), the warranty period will be 50-years from the date of original installation of the products on the property, prorated as outlined in the Warranty Coverage Schedule contained within. This Limited Lifetime Warranty is limited to the original owner. Coverage will be 100% for ten years after the installation and prorated after that period. See Warranty Coverage Schedule section for details of prorated coverage.

WHAT WILL ACM DO?

Property owner must notify the ACM Warranty Department in accordance with the notice requirements outlined below to validate the complaint. In the event the manufacturer is denied access for an inspection, this warranty is null and void. Upon the notification and validation, ACM will undertake the following: ACM will repair, repaint, replace, or refund the purchase price of the defective portion of ACM product that blisters, cracks, crazes, flakes, peels, or weathers unevenly due to a defect in the manufacturing process. ACM's obligations under this warranty will in no event exceed the purchase price of the originally installed products found to be warrantable in the original installation of such defective products. Any additional costs and expenses beyond these amounts are the property owner's responsibility. ACM will not pay or be responsible for any costs associated with anything else affixed to the ACM product.

In the event of repair, replacement, or refinishing, the warranty will extend only for the time remaining under the original warranty. ACM will determine the reasonable labor costs to repair, repaint, or replace product under this warranty.

WHAT IS NOT COVERED UNDER THE WARRANTY?

- This warranty does not cover damage of any kind resulting from:
- Uninstalled product that is stored in situations where standing water is covering the surface for a prolonged period of time.
 - Faulty or improper installation, including "oil canning" waving, buckling, or other distortions. Flat roof applications require minimum of 24 ga. steel material.
 - Installation of ACM product in direct contact with dissimilar materials, salt spray, and cedar shake roofing. Cracking or crazing of the product's paint surface due to field forming of products in cold temperatures; or material that has bends less than 2T for a sheet thickness of 0.0299" and thinner and bends less than 4T for a sheet thickness of 0.0300" and thicker.
 - Changes in surface color resulting from chalking, fading, soiling, tree sap, or staining. Exposure to the elements may cause these changes over time. The degree to which weathering occurs will vary depending on air quality, the building's location, and other local conditions over which ACM has no control.
 - Accidental damage.
 - Settlement.
 - Structural shrinkage or distortion of the property structure.
 - Fire.
 - Lightning, hurricane, tornado, windstorm, earthquake, hail, ice damage or other acts of God.
 - Issues stemming from ice damming and the common remedies including the use of ice rakes, salt or deicing chemicals, and high pressure steam spraying.
 - Harmful chemicals including cleaning compounds, herbicides, fertilizers, and pesticides.
 - Fumes, volcanic smog, or vapors within 30-miles of volcano.
 - Surface deterioration due to air pollution, use for animal confinement structures, or within a mile of a seacoast or other bodies of saltwater.
 - Misuse or abuse. Use of high pressure sprayers voids warranty.
 - Vandalism.
 - Airborne stains, mold and mildew accumulation.
 - Tiger striping or atmospheric soil accumulation is a naturally occurring phenomenon that is not covered under the finish warranty.
 - Failure of original property owners to provide reasonable and necessary maintenance of the products.
 - Impact of foreign objects.
 - Warping or distortion due to exposure to excessive heat sources. Products that have been painted, reinstalled, or whose surface has been altered in any manner will void the warranty.
 - Any other causes beyond the reasonable control of ACM.

Continued on next page →

ACM Customer Service

MW / NE - 877-279-5096

SE - 800-749-4067

SW - 800-357-7523

W - 877-213-5962

EDGE METALS



ACM is a "one stop shop" manufacturing system for all your exterior metal products.

ACM manufactures rainware, edge metals, trim coil, soffit and fascia, and siding accessories. We are constantly upgrading our plants and machinery to improve quality, add additional profiles, and create new innovative products.

Aluminum is made with majority of post consumer waste.

Aluminum and steel are recyclable, aluminum even more so. Did you know that Aluminum can be recycled over and over again? 75% of all aluminum ever smelted is still being recycled.

We keep Green Circle Certificates on hand for your access proving that 75% more of our raw material comes from recycled consumer waste. You may use this information to advertise that you are a "Green" company or as back-up documentation for government projects.

For Customer Service: 800-749-4067



EDGE METALS

Apollo Beach Plant Coverage Region

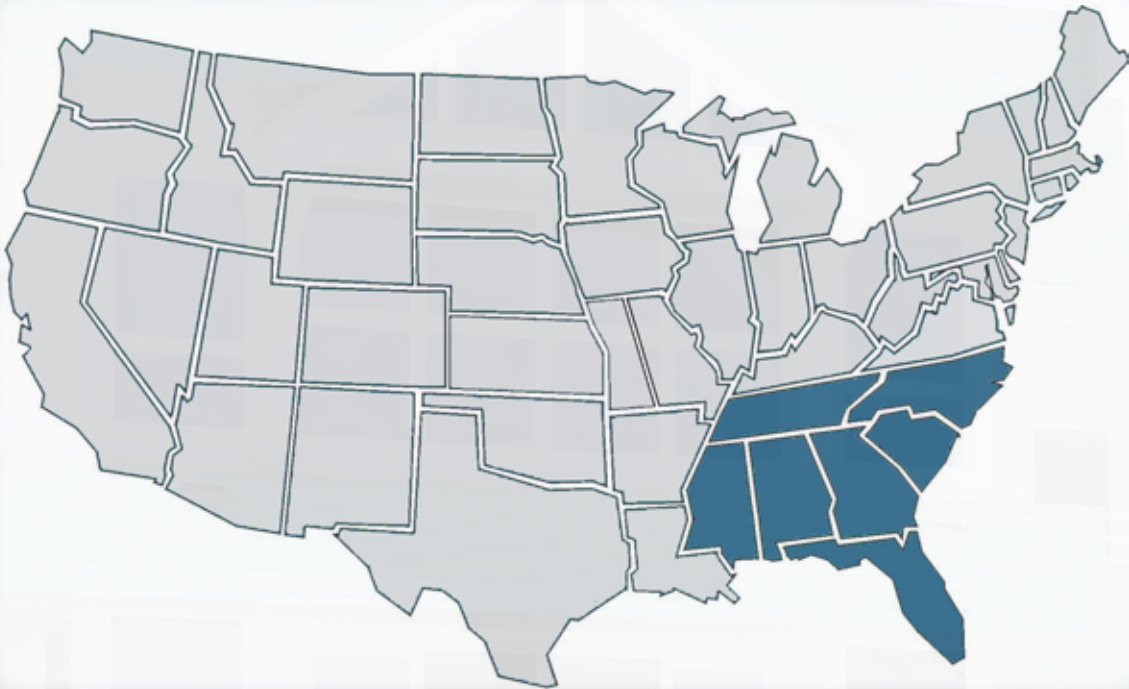

Customer Service: Ph 800-749-4067 • Fax 608-364-0598
www.acm-metals.com